

# ACB / MCCB / ELCB / ATS MCB / SPD / MS / MMS



**KIM QUANG ELECTRIC DISTRIBUTOR**

Hotline: 0931 455 668

Sales: 0909 635 266 – 0938 118 428

**SHIHLIN ELECTRIC & ENGINEERING**

## Index

<b>A. MCCB/ EMCCB/ ELCB / MCB</b>	<b>P02</b>
<b>B. ATS (MCCB TYPE \ MS TYPE)</b>	<b>P32</b>
<b>C. ACB</b>	<b>P35</b>
<b>D. MCB/ RCBO</b>	<b>P36</b>
<b>E. SPD / TVSS</b>	<b>P40</b>
<b>F. MS</b>	<b>P41</b>
<b>G. MMS</b>	<b>P61</b>

Index

MCCB  
ELCB

ATS

ACB

MCB

SPD

MS

MMS

### MCCB Frame Size Selection Table

Frame Size	Type	Rated Breaking Capacity (kA)					Pole	Rated Current In(A)	Accessory		
		IEC60947-2							Blank	No Acc.	
		220V	380V	415V	440V	500V					
30	CN	2.5	1.5	1.5	-	-	2, 3	3, 5, 10, 15, 20, 30.	Blank	No Acc.	
	SN	5	2.5	2.5	2.5	1.5	3		AX	Auxiliary Switch	
50	CN	5	2.5	2.5	2.5	1.5	2, 3	10, 15, 20, 30, 40, 50.	AL	Alarm Switch	
60	HBN	50	30	25	25	15	3	10, 15, 20, 30, 40, 50, 60.	SHT	Shunt Trip	
63	SN	10	7.5	7.5	7.5	5	2, 3, 4	10, 15, 16, 20, 25, 30, 32, 40, 50, 60, 63	UVT	Under Voltage Trip	
	HN	25	15	10	10	5	2, 3, 4				
100	FTD	25	5	5	-	-	1	15, 20, 30, 40, 50, 60, 75, 100			
	MN	15	10	10	7.5	5	2, 3	10, 15, 20, 30, 40, 50, 60, 75, 100.			
	SN	25	15	10	10	7.5	2, 3, 4				
	HN	50	30	25	25	15	2, 3, 4	40, 50, 63, 80, 100.			
	HS	125	85	85	70	50	3, 4				
	BTD	25	15	10	10	5*	2, 3, 4				
	STD	50	30	25	25	5*	2, 3, 4		15, 16, 20, 25, 30, 32, 40, 50, 60, 63, 75, 80, 100		
	125	LTD	85	36	36	32	5*	2, 3, 4	15, 20, 30, 40, 50, 60, 75, 100, 125.		
SN		30	22	22	15	7.5	2, 3, 4				
HN		50	30	25	25	15	2, 3, 4	10, 15, 16, 20, 25, 30, 32, 40, 50, 60, 63, 70, 75, 80, 100, 125.			
LTD		85	36	36	32	5*	2, 3, 4				
HTA		100	50	50	50	10*	2, 3, 4				
RTA		100	70	70	50	10*	2, 3, 4				
160	SN	50	30	25	25	15	2, 3, 4	125, 140, 160.			
	HN	85	36	36	32	20	3, 4				
	HS	125	85	85	70	50	3, 4	40, 50, 60, 63, 70, 75, 80, 100, 125, 140, 150, 160.			
	HTA	100	50	50	50	10*	3, 4				
250	RTA	100	70	70	50	10*	3, 4	125, 150, 175, 200, 225, 250.			
	CN	30	22	15	15	7.5	2, 3, 4				
	SN	50	30	25	25	15	3, 4	175, 200, 225, 250.			
	HN	85	36	36	32	20	3, 4				
	HTA	100	50	50	50	10*	3, 4				
	RTA	100	70	70	50	10*	3, 4				
	400	HS	125	85	85	70	50	3, 4	175, 200, 225, 250.		
		CN	35	25	25	22	14	2, 3, 4			
SN		50	35	35	30	20	3, 4	250, 300, 350, 400.			
HN		85	50	50	42	25	3, 4				
630s	RN	100	70	70	55	42	3, 4	400, 500, 600, 630.			
	UN	125	85	85	85	65	3, 4				
	STD(STA)	36	25	25	25	10*	3, 4				
	LTD(LTA)	65	36	36	36	10*	3, 4				
630	HTD(HTA)	85	50	50	50	10*	3, 4	500, 630.			
	RTD(RTA)	100	70	70	70	15*	3, 4				
	CN	35	25	25	22	14	2, 3, 4				
	SN	50	35	35	30	20	3, 4				
	HN	85	50	50	50	25	3, 4				
800	RN	100	70	70	70	42	3, 4	700, 800.			
	UN	125	100	85	85	65	3, 4				
	CN	50	35	35	30	20	3, 4				
	SN	85	50	50	50	25	3, 4				
1000	HS	130	100	85	85	65	3	1000			
1200	HS	130	100	85	85	65	3	1200			
1600	HS	130	100	85	85	65	3	1400, 1600.			

Note 1. There is no SHT for 100HS, 30A and below.  
 2. There is no UVT for 100HS, 160HS, 250HS.  
 3. Mark \* kA rating is 690V.

### ELCB Frame Size Selection Table

Frame Size	Rated Breaking Capacity (kA)				Pole	Rated Current In(A)	Accessory	
	Type	IEC60947-2						
		220V	380V	440V				
50	SN	10	7.5	7.5	3, 4	15, 20, 30, 40, 50.	Blank	No Acc.
100	SN	25	15	10	3, 4	15, 20, 30, 40, 50, 60, 75, 100.	AX	Auxiliary Switch
	HN	50	30	25	3, 4		AL	Alarm Switch
160	SN	50	30	25	3, 4	125, 140, 160.	SHT	Shunt Trip
250	SN	50	30	25	3, 4	175, 200, 225, 250.	UVT	Under Voltage Trip
400	SN	50	35	30	3, 4	250, 300, 350, 400.		
	HN	85	50	42	3, 4			
	RN	100	70	55	3, 4			
	UN	125	85	85	3, 4			
630	HN	85	50	50	3, 4	500, 630.		
	RN	100	70	70	3, 4			
800	UN	125	100	85	3, 4	700, 800.		
	SN	85	50	50	3, 4			
	HN	100	70	70	3, 4			
	RN	125	100	85	3, 4			

Breaker & Switchgear System

Index

MCCB  
ELCB

ATS

ACB

MCB

SPD

MS

MMS

### BMA Series Frame Size Selection Table

Frame Size	Type	Rated Breaking Capacity (kA)			Pole	Ir Adjustable	Rated Current In(A)	Accessory	
		IEC60947-2						Blank	No Acc.
		220V(240V)	380V(415V)	690V					
125	STA	85	25	8	3, 4	0.8-0.9-1.0	15, 16, 20, 25, 30, 32, 40, 50, 60, 63, 75, 80, 100, 125	Blank	No Acc.
	LTA	85	36	8				AX	Auxiliary Switch
	HTA	100	50	10				AL	Alarm Switch
160	STA	85	25	8	3, 4	0.8-0.9-1.0	40, 50, 60, 63, 70, 75, 80, 100, 125, 140, 150, 160	SHT	Shunt Trip
	LTA	85	36	8				UVT	Under Voltage Trip
	HTA	100	50	10					
250	STA	85	25	8	3, 4	0.8-0.9-1.0	175, 200, 225, 250		
	LTA	85	36	8					
	HTA	100	50	10					
400	LTA	70	36	8	3, 4	0.8-0.9-1.0	250, 300, 350, 400		
	HTA	85	50	10					
	RTA	100	70	15					
630s	STD	36	25	10	3, 4	N/A	400, 500, 600, 630		
	LTD	65	36	10					
	HTD	85	50	10					
	RTD	100	70	15					
630	HTD	85	50	10	3, 4	0.8-0.9-1.0	500, 600, 630		
	RTD	100	70	15					
	HTA	85	50	10					
800	HTD	85	50	10	3, 4	0.4-0.48-0.56-0.64-0.72-0.8-0.9-1.0	630		
	RTD	100	70	15					
	HTA	85	50	10					
1250	HTD	85	50	10	3, 4	0.4-0.48-0.56-0.64-0.72-0.8-0.9-1.0	700, 800		
	RTD	100	70	15					
	HTA	85	50	10					
1600	HTD	85	50	10	3, 4	0.4-0.48-0.56-0.64-0.72-0.8-0.9-1.0	800		
	RTD	100	70	15					
	HTA	85	50	10					
1250	HED	-	50	35	3, 4	0.4-0.45-0.5-0.6-0.63-0.7-0.8-0.9-1	1250		
	RED	-	70	45					
1600	HED	-	50	35	3, 4	0.4-0.45-0.5-0.6-0.63-0.7-0.8-0.9-1	1600		
	RED	-	70	45					

Index

MCCB  
ELCB

ATS

ACB

MCB

SPD

MS

MMS

**MCCB/ELCB Breaking Capacity Selection Table**

Series	Rated Breaking Capacity (kA)	Frame Size/ Rated Current In (A)											
	IEC60947-2	30	50/60	100	125	160	250	400	630	800	1000	1200	1600
	AC380V												
BM	100kA								630-UN	800-RN	1000-HS	1200-HS	1600-HS
	85kA			100-HS		160-HS	250-HS	400-UN					
	70kA				125-RTA	160-RTA	250-RTA	400-RN	630-RN 630s-RTD	800-HN			
	50kA				125-HTA	160-HTA	250-HTA	400-HN	630-HN 630s-HTD	800-SN			
	35/36kA			100-LTD	125-LTD	160-HN	250-HN	400-SN	630-SN 630s-LTD	800-CN			
	30kA		60-HBN	100-HN 100-STD		160-SN	250-SN						
	25kA				125-HN				630s-STD				
	15kA		60-HN 63-HN	100-SN 100-BTD	125-SN								
	10kA				100-MN								
	7.5kA		60-SN 63-SN										
BL	2.5kA	30-SN	50-CN										
	1.5kA	30-CN											
	100kA								630-UN	800-RN			
	85kA							400-RN					
	70kA							400-RN	630-RN	800-HN			
	50kA							400-HN	630-HN	800-SN			
	35kA							400-SN					
	30kA			100-HN		160-SN	250-SN						
	15kA			100-SN									
	10kA												
7.5kA		50-SN											

Index

MCCB  
ELCB

ATS

ACB





MCB

SPD





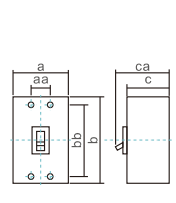

MS

MMS

## Molded Case Circuit Breaker

Frame size (AF) (Inm)		30		50		60			
Type		BM30-CN		BM30-SN		BM50-CN		BM60-HBN	
Appearance									
Rated current In (A) at ambient temp. 40°C		3, 5, 10, 15, 20, 30.		3, 5, 10, 15, 20, 30.		10, 15, 20, 30, 40, 50.		10, 15, 20, 30, 40, 50, 60.	
Number of poles (P)		2	3	2	3	2	3	3	
Rated insulation voltage Ui (V)	AC	690		800		800		800	
	DC	—		—		—		—	
Rated operational voltage Ue (V AC)		500		500		500		500	
Uimp(kV)		6		6		6		8	
Dimensions  (mm)	a	45	67.5	50	75	50	75	90	
	b	96		130		130		155	
	c	52		68		68		68	
	ca	67		90		90		90	
	bb	84		111		111		132	
	aa	23.5		25		25		30	
Weight (kg)		0.3	0.4	0.45	0.65	0.45	0.65	1.3	
Rated breaking capacity (kA)	IEC 60947-2 EN 60947-2 Icu AC	500V(690V)	—		1.5		1.5		15
		440V	—		2.5		2.5		25
		415V	1.5	2.5	2.5	2.5	25		
		380V	1.5	2.5	2.5	2.5	30		
		220V(240V)	2.5	5	5	5	50		
	DC	250V	—		—		—		—
		125V	—		—		—		—
Connection		Clamp terminal		Clamp terminal		Clamp terminal		Clamp terminal	
Optional accessories	Alarm switch (AL)	—		○		○		○	
	Auxiliary switch (AX)	—		○		○		○	
	Shunt trip (SHT)	—		○		○		○	
	Under-voltage trip (UVT)	—		○		○		○	
	Rotary handle (EH)	—		●		●		●	
	Terminal cover (TC)	●		●		●		●	
	Box lug (TL)	●		●		●		●	
Trip Unit		Hydraulic magnetic		Hydraulic magnetic		Hydraulic magnetic		Hydraulic magnetic	
Tripping button		—		Equipped		Equipped		Equipped	

Note 1. "●" which can be installed by client, "○" which have to be installed by manufacturer. "—" which is not available.  
 Above accessories table is for 3P breaker.  
 2. Ics= 50% Icu  
 3. Adjustable thermal: 80%~100% In.

63			100														
BM63-SN			BM63-HN			BM100-FTD			BM100-MN			BM100-SN			BM100-HN		
																	
10, 15, 16, 20, 25, 30, 32, 40, 50, 60, 63			10, 15, 16, 20, 25, 30, 32, 40, 50, 60, 63			15, 20, 30, 40, 50, 60, 75, 100.			10, 15, 20, 30, 40, 50, 60, 75, 100.			10, 15, 20, 30, 40, 50, 60, 75, 100.			10, 15, 20, 30, 40, 50, 60, 75, 100.		
2	3	4	2	3	4	1	2	3	2	3	2	3	4	2	3	4	
800			800			690			800			800			800		
—			—			—			—			250*			—		
500			500			415			500			500			500		
8			8			6			6			6			8		
50	75	100	50	75	100	25.4	50	75	50	75	50	75	60	90	120		
130			130			130			130			130			155		
68			68			60			68			68			68		
90			90			91			90			90			90		
111			111			111			111			111			132		
25			25			—			25			25			30		
0.45	0.65	0.85	0.45	0.65	0.85	0.29	0.45	0.65	0.45	0.65	0.45	0.65	0.9	1.3	1.6		
5			5			—			5			7.5			15		
7.5			10			—			7.5			10			25		
7.5			10			5			10			10			25		
7.5			15			5			10			15			30		
10			25			25			15			25			50		
—			—			—			—			10*			—		
—			—			—			—			15*			—		
Clamp terminal			Clamp terminal			Clamp terminal			Clamp terminal			Clamp terminal			Clamp terminal		
○			○			—			○			○			○		
○			○			—			○			○			○		
○			○			—			○			○			○		
○			○			—			○			○			○		
●			●			—			●			●			●		
●			●			—			●			●			●		
●			●			●			●			●			●		
Hydraulic magnetic			Hydraulic magnetic			Thermal magnetic			Hydraulic magnetic			Hydraulic magnetic			Hydraulic magnetic		
Equipped			Equipped			Equipped			Equipped			Equipped			Equipped		

Note 1. Breaking Capacity of BM100-FTD is 5kA at 380V/415V/440V  
 2.\* DC application MCCB trip characteristic is different from AC type, please specify when place the order.

Index

MCCB  
ELCB

ATS

ACB

MCB

SPD

MS

MMS







## Molded Case Circuit Breaker

Frame size (AF) (Inm)		100										
Model		BM100-HS		BM100-BTD			BM100-STD			BM100-LTD		
Appearance												
Rated current In (A) at ambient temp. 40°C		40, 50, 63, 80, 100.		15, 16, 20, 25, 30, 32, 40, 50, 60, 63, 75, 80, 100			15, 16, 20, 25, 30, 32, 40, 50, 60, 63, 75, 80, 100			10,15,16,20,25,30,32,40, 50,60,63,70,75,80,100		
Number of poles (P)		3	4	2	3	4	2	3	4	2	3	4
Rated insulation voltage Ui (V)	AC	800		800			800			800		
	DC	—		—			—			—		
Rated operational voltage Ue (V AC)		500		690			690			690		
Uimp(kV)		8		8			8			8		
Dimensions  (mm)	a	105	140	50	75	100	50	75	100	50	75	100
	b	165		130			130			130		
	c	86		68			68			68		
	ca	112		90			90			90		
	bb	126		111			111			111		
	aa	35		25			25			—	25	
Weight (kg)		2.1	2.6	0.5	0.7	0.9	0.5	0.7	0.9	0.5	0.7	0.9
Rated breaking capacity (kA)	IEC 60947-2 EN 60947-2 Icu AC	500V(690V)	50		(5)			(5)			20(5)	
		440V	70		10			25			32	
		415V	85		10			25			36	
		380V	85		15			30			36	
		220V(240V)	125		25			50			85	
	DC	250V	—		—			—			—	
		125V	—		—			—			—	
Connection		Clamp terminal		Clamp terminal			Clamp terminal			Clamp terminal		
Optional accessories	Alarm switch (AL)	○		●			●			●		
	Auxiliary switch (AX)	○		●			●			●		
	Shunt trip (SHT)	○		●			●			●		
	Under-voltage trip (UVT)	—		●			●			●		
	Rotary handle (EH)	●		●			●			●		
	Terminal cover (TC)	●		●			●			●		
	Box lug (TL)	●		●			●			●		
Trip Unit		Thermal magnetic		Thermal magnetic			Thermal magnetic			Thermal magnetic		
Tripping button		Equipped		Equipped			Equipped			Equipped		

Note 1. "●" which can be installed by client, "○" which have to be installed by manufacturer. "—" which is not available.  
 Above accessories table is for 3P breaker.  
 2. Ics= 50% Icu  
 3. Adjustable thermal: 80%~100% In.

125

BM125-SN			BM125-HN			BM125-LTD			BM125-HTA			BM125-RTA		
														
10, 15, 20, 30, 40, 50, 60, 75, 100, 125.			10, 15, 20, 30, 40, 50, 60, 75, 100, 125.			15, 16, 20, 25, 30, 32, 40, 50, 60, 63, 75, 80, 100, 125.			10,15,16,20,25,30,32,40, 50,60,63,70,75,80,100,125.			10,15,16,20,25,30,32,40, 50,60,63,70,75,80,100,125.		
2	3	4	2	3	4	2	3	4	2	3	4	2	3	4
800			800			800			800			800		
—			—			—			—			—		
500			500			690			690			690		
8			8			8			8			8		
60	90	120	60	90	120	50	75	100	90	120		90	120	
155			155			130			155			155		
68			68			68			68			68		
90			90			90			90			90		
132			132			111			132			132		
30			30			25			30			30		
0.5	0.7	0.9	0.5	0.7	0.9	0.5	0.7	0.9	1	1.2	1.5	1	1.2	1.5
7.5			15			(5)			25(10)			25(10)		
15			25			32			50			50		
22			25			36			50			70		
22			30			36			50			70		
30			50			85			100			100		
—			—			—			—			—		
—			—			—			—			—		
Clamp terminal			Clamp terminal			Clamp terminal			Clamp terminal			Clamp terminal		
○			○			●			●			●		
○			○			●			●			●		
○			○			●			●			●		
—	○	○	—	○	○	●			●			●		
●			●			●			●			●		
●			●			●			●			●		
●			●			●			●			●		
Hydraulic magnetic			Hydraulic magnetic			Thermal magnetic			"Adjustable Thermal Fixed magnetic"			"Adjustable Thermal Fixed magnetic"		
Equipped			Equipped			Equipped			Equipped			Equipped		

Index

MCCB  
ELCB

ATS

ACB

MCB

SPD

MS

MMS

## Molded Case Circuit Breaker

80% ~ 100% Adj. (A)

Frame size (AF) (Inm)		160											
Model		BM160-SN			BM160-HN		BM160-HTA		BM160-RTA		BM160-HS		
Appearance													
Rated current In (A) at ambient temp. 40°C		125, 140, 160.			125, 140, 160.		40, 50, 60, 63, 70, 75, 80, 100, 125, 140, 150, 160		40, 50, 60, 63, 70, 75, 80, 100, 125, 140, 150, 160		125, 140, 160.		
Number of poles (P)		2	3	4	3	4	3	4	3	4	3	4	
Rated insulation voltage Ui (V)		AC		800		800		800		800		690	
		DC		—		—		—		—		—	
Rated operational voltage Ue (V AC)		500			500		690		690		500		
Uimp(kV)		8			8		8		8		8		
Dimensions 	a	105	105	140	105	140	105	140	105	140	105	140	
	b	165			165		165		165		165		
	c	68			68		68		68		86		
	ca	92			92		92		92		112		
	bb	126			126		126		126		126		
	aa	35			35		35		35		35		
Weight (kg)		1.3	1.5	1.9	1.5	1.9	1.5	1.9	1.5	1.9	2.1	2.6	
Rated breaking capacity (kA)	IEC 60947-2 EN 60947-2 Icu AC	500V(690V)	15			20		25(10)		25(10)		50	
		440V	25			32		50		50		70	
		415V	25			36		50		70		85	
		380V	30			36		50		70		85	
		220V(240V)	50			85		100		100		125	
	DC	250V	—			—		—		—		—	
		125V	—			—		—		—		—	
Connection		Clamp terminal			Clamp terminal		Clamp terminal		Clamp terminal		Clamp terminal		
Optional accessories	Alarm switch (AL)	●			●		●		●		○		
	Auxiliary switch (AX)	●			●		●		●		○		
	Shunt trip (SHT)	●			●		●		●		○		
	Under-voltage trip (UVT)	●			●		●		●		—		
	Rotary handle (EH)	●			●		●		●		●		
	Terminal cover (TC)	●			●		●		●		●		
	Box lug (TL)	●			●		●		●		●		
Trip Unit		Adj. thermal Fixed magnetic			Adj. thermal Fixed magnetic		Adj. thermal Fixed magnetic		Adj. thermal Fixed magnetic		Thermal magnetic		
Tripping button		Equipped			Equipped		Equipped		Equipped		Equipped		

Note \* DC application MCCB trip characteristic is different from AC type, please specify when place the order.

80% ~ 100% Adj. (A)

250

BM250-CN

BM250-SN

BM250-HN

BM250-HTA

BM250-RTA

BM250-HS



125, 150, 175, 200, 225, 250.			125, 150, 175, 200, 225, 250.			175, 200, 225, 250.			175, 200, 225, 250.			175, 200, 225, 250.			175, 200, 225, 250.		
2	3	4	3	4	3	4	3	4	3	4	3	4	3	4			
800			800			800			800			800			800		
250*	—	—	—	—	—	—	—	—	—	—	—	—	—	—			
500			500			500			690			690			500		
8			8			8			8			8			8		
105	105	140	105	140	105	140	105	140	105	140	105	140	105	140	105	140	
165			165			165			165			165			165		
68			68			68			68			68			86		
92			92			92			92			92			112		
126			126			126			126			126			126		
35			35			35			35			35			35		
1.3	1.5	1.9	1.5	1.9	1.5	1.9	1.5	1.9	1.5	1.9	1.5	1.9	2.1	2.6			
7.5			15			20			25(10)			25(10)			50		
15			25			32			50			50			70		
15			25			36			50			70			85		
22			30			36			50			70			85		
30			50			85			100			100			125		
10*	—	—	—	—	—	—	—	—	—	—	—	—	—	—			
15*	—	—	—	—	—	—	—	—	—	—	—	—	—	—			
Clamp terminal			Clamp terminal			Clamp terminal			Clamp terminal			Clamp terminal			Clamp terminal		
●	●	●	●	●	●	●	●	●	●	●	●	●	○	○			
●	●	●	●	●	●	●	●	●	●	●	●	●	○	○			
●	●	●	●	●	●	●	●	●	●	●	●	●	○	○			
●	●	●	●	●	●	●	●	●	●	●	●	●	—	—			
●	●	●	●	●	●	●	●	●	●	●	●	●	●	●			
●	●	●	●	●	●	●	●	●	●	●	●	●	●	●			
●	●	●	●	●	●	●	●	●	●	●	●	●	●	●			
Adj. thermal Fixed magnetic			Adj. thermal Fixed magnetic			Adj. thermal Fixed magnetic			Adj. thermal Fixed magnetic			Adj. thermal Fixed magnetic			Thermal magnetic		
Equipped			Equipped			Equipped			Equipped			Equipped			Equipped		

Note \* DC application MCCB trip characteristic is different from AC type, please specify when place the order.

Index

MCCB  
ELCB

ATS

ACB

MCB

SPD

MS

MMS

BO









11

## Molded Case Circuit Breaker

Frame size (AF) (Inm)		400												
Model	BM400-CN	BM400-SN			BM400-HN		BM400-RN		BM400-UN					
Appearance														
Rated current In (A) at ambient temp. 40°C	250, 300, 350, 400.			250, 300, 350, 400.		250, 300, 350, 400.		250, 300, 350, 400.		250, 300, 350, 400.				
Number of poles (P)	2	3	4	3	4	3	4	3	4	3	4			
Rated insulation voltage Ui (V)	AC	690			690		690		690		690			
	DC	250*	—	—	—	—	—	—	—	—	—			
Rated operational voltage Ue (V AC)	500			500		500		500		500				
Uimp(kV)	8			8		8		8		8				
Dimensions 	a	140	140	185	140	185	140	185	140	185	140	185		
	b	257			257		257		257		257			
	c	103			103		103		103		103			
	ca	155			155		155		155		155			
	bb	194			194		194		194		194			
	aa	44			44		44		44		44			
Weight (kg)	5.0	5.7	7.5	5.7	7.5	5.7	7.5	5.7	7.5	5.7	7.5			
Rated breaking capacity (kA)	IEC 60947-2 EN 60947-2 Icu	500V(690V)	14			20		25		42		65		
		440V	22			30		42		55		85		
		415V	25			35		50		70		85		
		380V	25			35		50		70		85		
		220V(240V)	35			50		85		100		125		
	DC	250V	10*	—	—	—	—	—	—	—	—	—		
125V		15*	—	—	—	—	—	—	—	—	—			
Connection	Busbar/ Without busbar			Busbar/ Without busbar		Busbar/ Without busbar		Busbar/ Without busbar		Busbar/ Without busbar				
Optional accessories	Alarm switch	(AL)	●	●	●	●	●	●	●	●	●			
	Auxiliary switch	(AX)	●	●	●	●	●	●	●	●	●			
	Shunt trip	(SHT)	●	●	●	●	●	●	●	●	●			
	Under-voltage trip	(UVT)	●	●	●	●	●	●	●	●	●			
	Rotary handle	(EH)	●	●	●	●	●	●	●	●	●			
	Terminal cover	(TC)	●	●	●	●	●	●	●	●	●			
	Box lug	(TL)	●	●	●	●	●	●	●	●	●			
Trip Unit	Thermal magnetic			Thermal magnetic		Thermal magnetic		Thermal magnetic		Thermal magnetic				
Tripping button	Equipped			Equipped		Equipped		Equipped		Equipped				

Note 1. "●" which can be installed by client, "○" which have to be installed by manufacturer. "—" which is not available.  
 Above accessories table is for 3P breaker.  
 2. Ics= 50% Icu  
 3. Adjustable thermal: 80%~100% In.  
 4. \* DC application MCCB trip characteristic is different from AC type, please specify when place the order.

630

BM630s-STD		BM630s-LTD		BM630s-HTD		BM630s-RTD		BM630s-STA		BM630s-LTA		BM630s-HTA		BM630s-RTA	
															
400, 500, 600, 630.		400, 500, 600, 630.		400, 500, 600, 630.		400, 500, 600, 630.		400, 500, 600, 630.		400, 500, 600, 630.		400, 500, 600, 630.		400, 500, 600, 630.	
3	4	3	4	3	4	3	4	3	4	3	4	3	4	3	4
1000		1000		1000		1000		1000		1000		1000		1000	
—		—		—		—		—		—		—		—	
690		690		690		690		690		690		690		690	
8		8		8		8		8		8		8		8	
140	185	140	185	140	185	140	185	140	185	140	185	140	185	140	185
257		257		257		257		257		257		257		257	
103		103		103		103		103		103		103		103	
155		155		155		155		155		155		155		155	
194		194		194		194		194		194		194		194	
44		44		44		44		44		44		44		44	
5.7	7	5.7	7	5.7	7	5.7	7	5.7	7	5.7	7	5.7	7	5.7	7
14(10)		20(10)		25(10)		42(15)		14(10)		20(10)		25(10)		42(15)	
25		36		50		70		25		36		50		70	
25		36		50		70		25		36		50		70	
25		36		50		70		25		36		50		70	
36		65		85		100		36		65		85		100	
—		—		—		—		—		—		—		—	
—		—		—		—		—		—		—		—	
Busbar/ Without busbar		Busbar/ Without busbar		Busbar/ Without busbar		Busbar/ Without busbar		Busbar/ Without busbar		Busbar/ Without busbar		Busbar/ Without busbar		Busbar/ Without busbar	
●		●		●		●		●		●		●		●	
●		●		●		●		●		●		●		●	
●		●		●		●		●		●		●		●	
●		●		●		●		●		●		●		●	
●		●		●		●		●		●		●		●	
●		●		●		●		●		●		●		●	
●		●		●		●		●		●		●		●	
Thermal magnetic		Thermal magnetic		Thermal magnetic		Thermal magnetic		"Adjustable Thermal Fixed magnetic"		"Adjustable Thermal Fixed magnetic"		"Adjustable Thermal Fixed magnetic"		"Adjustable Thermal Fixed magnetic"	
Equipped		Equipped		Equipped		Equipped		Equipped		Equipped		Equipped		Equipped	







Note \* DC application MCCB trip characteristic is different from AC type, please specify when place the order.

- Index
- MCCB  
ELCB
- ATS
- ACB
- MCB
- SPD
- MS
- MMS

## Molded Case Circuit Breaker

Frame size (AF) (Inm)		630										
Model		BM630-CN		BM630-SN		BM630-HN		BM630-RN		BM630-UN		
Appearance												
Rated current In (A) at ambient temp. 40°C		500, 600, 630.		500, 600, 630.		500, 630.		500, 630.		500, 630.		
Number of poles (P)		3	4	3	4	3	4	3	4	3	4	
Rated insulation voltage Ui (V)		AC		1000		1000		1000		1000		
		DC		250*		250*		250*		—		
Rated operational voltage Ue (V AC)		500		500		500		500		500		
Uimp(kV)		8		8		8		8		8		
Dimensions 	a	210	280	210	280	210	280	210	280	210	280	
	b	275		275		275		275		275		
	c	103		103		103		103		103		
	ca	155		155		155		155		155		
	bb	243		243		243		243		243		
	aa	70		70		70		70		70		
Weight (kg)		10	13	10	13	10	13	10	13	10	13	
Rated breaking capacity (kA)	IEC 60947-2 EN 60947-2 Icu AC	500V(690V)	14		20		25		42		65	
		440V	22		30		50		70		85	
		415V	25		35		50		70		85	
		380V	25		35		50		70		100	
		220V(240V)	35		50		85		100		125	
	DC	250V	10*	—	20*	—	40*	—	—	—	—	—
		125V	—		—		—		—		—	
Connection		Busbar/ Without busbar		Busbar/ Without busbar		Busbar/ Without busbar		Busbar/ Without busbar		Busbar/ Without busbar		
Optional accessories	Alarm switch (AL)	●		●		●		●		●		
	Auxiliary switch (AX)	●		●		●		●		●		
	Shunt trip (SHT)	●		●		●		●		●		
	Under-voltage trip (UVT)	●		●		●		●		●		
	Rotary handle (EH)	●		●		●		●		●		
	Terminal cover (TC)	●		●		●		●		●		
	Box lug (TL)	●		●		●		●		●		
Trip Unit		Fixed thermal Adj. magnetic		Fixed thermal Adj. magnetic		Fixed thermal Adj. magnetic		Fixed thermal Adj. magnetic		Fixed thermal Adj. magnetic		
Tripping button		Equipped		Equipped		Equipped		Equipped		Equipped		

Note 1 "●" which can be installed by client, "○" which have to be installed by manufacturer. "—" which is not available.  
 Above accessories table is for 3P breaker.  
 2. Ics= 50% Icu  
 3. \* DC application MCCB trip characteristic is different from AC type, please specify when place the order.

800				1000	1200	1600		
BM800-CN		BM800-SN		BM800-HN	BM800-RN	BM1000-HS	BM1200-HS	BM1600-HS
								
700, 800.		700, 800.		700, 800.	700, 800.	1000	1200	1400, 1600.
3	4	3	4	3	4	3	3	3
690		690		1000	1000	1000	1000	1000
250*	—	250*	—	—	—	—	—	—
500		500		500	500	500	500	500
8		8		8	8	8	8	8
210	280	210	280	210	280	210	210	210
275		275		275	275	406	406	406
103		103		103	103	140	140	140
155		155		155	155	190	190	190
243		243		243	243	375	375	375
70		70		70	70	70	70	70
10.5	13.5	10.5	13.5	10.5	13.5	10.5	13.5	23
20		25		42	65	65	65	65
30		50		70	85	85	85	85
35		50		70	85	85	85	85
35		50		70	100	100	100	100
50		85		100	125	130	130	130
20*	—	40*	—	—	—	—	—	—
—		—		—	—	—	—	—
Busbar/ Without busbar		Busbar/ Without busbar		Busbar/ Without busbar	Busbar/ Without busbar	Busbar	Busbar	Busbar
●		●		●	●	○	○	○
●		●		●	●	○	○	○
●		●		●	●	○	○	○
●		●		●	●	○	○	○
●		●		●	●	—	—	—
●		●		●	●	—	—	—
●		●		●	●	●	●	●
Fixed thermal Adj. magnetic		Fixed thermal Adj. magnetic		Fixed thermal Adj. magnetic	Fixed thermal Adj. magnetic	Fixed thermal Adj. magnetic	Fixed thermal Adj. magnetic	Fixed thermal Adj. magnetic
Equipped		Equipped		Equipped	Equipped	Equipped	Equipped	Equipped

Index

MCCB  
ELCB

ATS

ACB

MCB

SPD

MS

MMS

Note \* DC application MCCB trip characteristic is different from AC type, please specify when place the order.











### Molded Case Circuit Breaker (BMA Series)

Frame size (AF) (Inm)		125			160			250			400			
Model		BMA 125-STA	BMA 125-LTA	BMA 125-HTA	BMA 160-STA	BMA 160-LTA	BMA 160-HTA	BMA 250-STA	BMA 250-LTA	BMA 250-HTA	BMA 400-LTA	BMA 400-HTA	BMA 400-RTA	
Appearance														
Rated current In (A) at ambient temp. 40°C		15,16,20,25,30,32,40,50,60,63,75,80,100,125A			40,50,60,63,70,75,80,100,125,140,150,160A			175,200,225,250A			250, 300, 350, 400A			
Number of poles (P)		3		4		3		4		3		4		
Rated insulation voltage Ui (V)		AC 800												
Rated operational voltage Ue(V AC)		690												
Uimp(kV)		8												
Dimensions		a	90	120	105	140	105	140	140	185				
		b	155	155	165	165	165	165	257	257				
		c	68	68	68	68	68	68	103	103				
		ca	92	92	92	92	92	92	155	155				
		bb	132	132	126	126	126	126	194	194				
		aa	30	30	35	35	35	35	44	44				
		Weight (kg)	0.7	0.9	1.5	1.9	1.5	1.9	5.7	7.5				
Rated breaking capacity (kA)	IEC 60947-2 EN 60947-2 Icu AC	690V	8 kA	8 kA	10 kA	8 kA	8 kA	10 kA	8 kA	8 kA	10 kA	8 kA	10 kA	15 kA
		415V	25 kA	36 kA	50 kA	25 kA	36 kA	50 kA	25 kA	36 kA	50 kA	36 kA	50 kA	70 kA
		380V	25 kA	36 kA	50 kA	25 kA	36 kA	50 kA	25 kA	36 kA	50 kA	36 kA	50 kA	70 kA
		220V(240V)	85 kA	85 kA	100 kA	85 kA	85 kA	100 kA	85 kA	85 kA	100 kA	70 kA	85 kA	100 kA
Connection		Clamp terminal	Clamp terminal	Clamp terminal	Clamp terminal	Clamp terminal	Clamp terminal	Clamp terminal	Clamp terminal	Clamp terminal	Busbar	Busbar	Busbar	
Optional accessories	Alarm switch (AL)	●	●	●	●	●	●	●	●	●	●	●	●	
	Auxiliary switch (AX)	●	●	●	●	●	●	●	●	●	●	●	●	
	Shunt trip (SHT)	●	●	●	●	●	●	●	●	●	●	●	●	
	Under-voltage trip (UVT)	●	●	●	●	●	●	●	●	●	●	●	●	
	Rotary handle (EH)	●	●	●	●	●	●	●	●	●	●	●	●	
	Terminal cover (TC)	●	●	●	●	●	●	●	●	●	●	●	●	
Trip Unit		Adjustable Thermal Fixed Magnetic			Adjustable Thermal Fixed Magnetic			Adjustable Thermal Fixed Magnetic			Adjustable Thermal Fixed Magnetic			
Tripping button		Equipped	Equipped	Equipped	Equipped	Equipped	Equipped	Equipped	Equipped	Equipped	Equipped	Equipped	Equipped	

Note 1. Ics=100%Icu

630

BMA630s-STD		BMA630s-LTD		BMA630s-HTD		BMA630s-RTD		BMA630s-STA		BMA630s-LTA		BMA630s-HTA		BMA630s-RTA	
															
400, 500, 600, 630A		400, 500, 600, 630A		400, 500, 600, 630A		400, 500, 600, 630A		400, 500, 600, 630A		400, 500, 600, 630A		400, 500, 600, 630A		400, 500, 600, 630A	
3	4	3	4	3	4	3	4	3	4	3	4	3	4	3	4
1000		1000		1000		1000		1000		1000		1000		1000	
690		690		690		690		690		690		690		690	
8		8		8		8		8		8		8		8	
140	185	140	185	140	185	140	185	140	185	140	185	140	185	140	185
257		257		257		257		257		257		257		257	
103		103		103		103		103		103		103		103	
155		155		155		155		155		155		155		155	
194		194		194		194		194		194		194		194	
44		44		44		44		44		44		44		44	
5.7	7	5.7	7	5.7	7	5.7	7	5.7	7	5.7	7	5.7	7	5.7	7
10 kA		10 kA		10 kA		15 kA		10 kA		10 kA		10 kA		15 kA	
25 kA		36 kA		50 kA		70 kA		25 kA		36 kA		50 kA		70 kA	
25 kA		36 kA		50 kA		70 kA		25 kA		36 kA		50 kA		70 kA	
36 kA		65 kA		85 kA		100 kA		36 kA		65 kA		85 kA		100 kA	
Clamp terminal		Clamp terminal		Clamp terminal		Clamp terminal		Clamp terminal		Clamp terminal		Clamp terminal		Clamp terminal	
●	●	●	●	●	●	●	●	●	●	●	●	●	●	●	●
●	●	●	●	●	●	●	●	●	●	●	●	●	●	●	●
●	●	●	●	●	●	●	●	●	●	●	●	●	●	●	●
●	●	●	●	●	●	●	●	●	●	●	●	●	●	●	●
●	●	●	●	●	●	●	●	●	●	●	●	●	●	●	●
●	●	●	●	●	●	●	●	●	●	●	●	●	●	●	●
Thermal magnetic	Thermal magnetic	Thermal magnetic	Thermal magnetic	Thermal magnetic	Adjustable Thermal Fixed magnetic	Adjustable Thermal Fixed magnetic	Adjustable Thermal Fixed magnetic	Adjustable Thermal Fixed magnetic	Adjustable Thermal Fixed magnetic	Adjustable Thermal Fixed magnetic	Adjustable Thermal Fixed magnetic	Adjustable Thermal Fixed magnetic	Adjustable Thermal Fixed magnetic	Adjustable Thermal Fixed magnetic	
Equipped	Equipped	Equipped	Equipped	Equipped	Equipped	Equipped	Equipped	Equipped	Equipped	Equipped	Equipped	Equipped	Equipped	Equipped	

Index

MCCB  
ELCB

ATS

ACB

MCB

SPD

MS

MMS

### Molded Case Circuit Breaker (BMA Series)

Frame size (AF) (Inm)		630				630				630				800				800				800								
Model		BMA 630-HTD		BMA 630-RTD		BMA 630-HTA		BMA 630-RTA		BMA 630-HED		BMA 630-RED		BMA 800-HTD		BMA 800-RTD		BMA 800-HTA		BMA 800-RTA		BMA 800-HED		BMA 800-RED						
Appearance																														
Rated current In (A) at ambient temp. 40°C		500, 600, 630A				500, 600, 630A				630A				700, 800A				700, 800A				800A								
Number of poles (P)		3	4	3	4	3	4	3	4	3	4	3	4	3	4	3	4	3	4	3	4	3	4	3	4	3	4	3	4	
Rated insulation voltage Ui (V)		AC 1000				1000				1000				1000				1000				1000								
Rated operational voltage Ue(V AC)		690				690				690				690				690				690								
Uimp(kV)		8				8				8				8				8				8								
Dimensions		a	210	280	210	280	210	280	210	280	210	280	210	280	210	280	210	280	210	280	210	280	210	280	210	280	210	280	210	280
		b	275				275				275				275				275				275							
		c	103				103				103				103				103				103							
		ca	155				155				155				155				155				155							
		bb	243				243				243				243				243				243							
		aa	70				70				70				70				70				70							
		(mm)																												
Weight (kg)		10	13	10	13	10	13	10	13	11.5	15.3	11.5	15.3	10	13	10	13	10	13	10	13	10	13	10	13	12	15.8	12	15.8	
Rated breaking capacity (KA)	IEC 60947-2 EN 60947-2 AC lcu	690V	10kA	15kA	10kA	15kA	10kA	15kA	10kA	15kA	10kA	15kA	10kA	15kA	10kA	15kA	10kA	15kA	10kA	15kA	10kA	15kA	10kA	15kA	10kA	15kA				
		415V	50kA	70kA	50kA	70kA	50kA	70kA	50kA	70kA	50kA	70kA	50kA	70kA	50kA	70kA	50kA	70kA	50kA	70kA	50kA	70kA	50kA	70kA	50kA	70kA				
		380V	50kA	70kA	50kA	70kA	50kA	70kA	50kA	70kA	50kA	70kA	50kA	70kA	50kA	70kA	50kA	70kA	50kA	70kA	50kA	70kA	50kA	70kA	50kA	70kA				
		220V/240V	85kA	100kA	85kA	100kA	85kA	100kA	85kA	100kA	85kA	100kA	85kA	100kA	85kA	100kA	85kA	100kA	85kA	100kA	85kA	100kA	85kA	100kA	85kA	100kA				
Connection		Busbar		Busbar		Busbar		Busbar		Busbar		Busbar		Busbar		Busbar		Busbar		Busbar		Busbar		Busbar		Busbar				
Optional accessories	Alarm switch (AL)	●	●	●	●	●	●	●	●	●	●	●	●	●	●	●	●	●	●	●	●	●	●	●	●	●	●			
	Auxiliary switch (AX)	●	●	●	●	●	●	●	●	●	●	●	●	●	●	●	●	●	●	●	●	●	●	●	●	●	●			
	Shunt trip (SHT)	●	●	●	●	●	●	●	●	●	●	●	●	●	●	●	●	●	●	●	●	●	●	●	●	●	●			
	Under-voltage trip (UVT)	●	●	●	●	●	●	●	●	●	●	●	●	●	●	●	●	●	●	●	●	●	●	●	●	●	●			
	Rotary handle (EH)	●	●	●	●	●	●	●	●	●	●	●	●	●	●	●	●	●	●	●	●	●	●	●	●	●	●			
	Terminal cover (TC)	●	●	●	●	●	●	●	●	●	●	●	●	●	●	●	●	●	●	●	●	●	●	●	●	●	●			
Trip Unit		Fixed Thermal Adjustable Magnetic		Adjustable Thermal Fixed magnetic		Electronic		Fixed Thermal Adjustable Magnetic		Adjustable Thermal Fixed magnetic		Electronic																		
Tripping button		Equipped	Equipped	Equipped	Equipped	Equipped	Equipped	Equipped	Equipped	Equipped	Equipped	Equipped	Equipped																	

Note 1. lcs=100%lcu

Frame size (AF) (Inm)	1000				1250				1600			
Model	BMA 1000-HED	BMA 1000-RED	BMA 1250-HED	BMA 1250-RED	BMA 1600-HED	BMA 1600-RED	BMA 1600-HED	BMA 1600-RED	BMA 1600-HED	BMA 1600-RED	BMA 1600-HED	BMA 1600-RED



Rated current In (A) at ambient temp. 40°C	1000A				1250A				1600A			
Number of poles (P)	3	4	3	4	3	4	3	4	3	4	3	4
Rated insulation voltage Ui (V)	AC 1000				1000				1000			
Rated operation voltage Ue(V AC)	690				690				690			
Uimp(kV)	8				8				8			

Dimensions	Diagram	a		b		c		ca		bb		aa	
		210	280	210	280	210	280	210	280	210	280	199	339
		327		327		327		327		200		199 339	
		141		141		141		141		200		199 339	
		205		205		205		205		200		199 339	
		200		200		200		200		200		199 339	
		199 339		199 339		199 339		199 339		199 339		199 339	

Weight (kg)	13.3	17.2	13.3	17.2	13.3	17.2	13.3	17.2	13.3	17.2	13.3	17.2
-------------	------	------	------	------	------	------	------	------	------	------	------	------

Rated breaking capacity (kA)	IEC 60947-2 EN 60947-2 AC	690V	35	45	35	45	35	45	35	45
		415V	50	70	50	70	50	70	50	70
		380V	50	70	50	70	50	70	50	70
		220V(240V)	—	—	—	—	—	—	—	—

Accessory	AL/AX/SHT/ Rotary handle	AL/AX/SHT/ Rotary handle	AL/AX/SHT/ Rotary handle
-----------	-----------------------------	-----------------------------	-----------------------------

**Condition:**

1. Operation Temp.: -25°C ~ +70 °C
2. Storage Temp.: -40 °C ~ 85 °C
3. Altitude: ≤2000m
4. Pollution class: 3
5. Category: B
6. Relative humidity: ≤ 90%

**Neutral Protection:**



4P4D: 100% In 3D+N/2: 50% In 4P3D: No protection

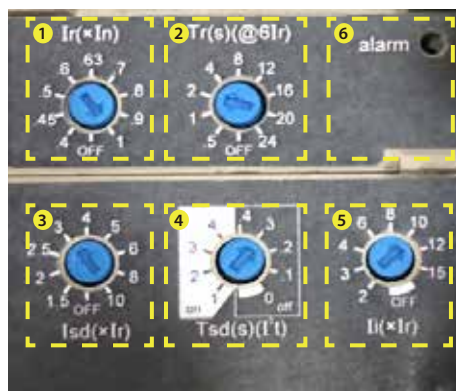

1. Overload Setting Knob (Ir=0.4/0.45/0.5/0.6/0.63/0.7/0.8/0.9/1/OFF)
2. Overload Tripping Time Setting Knob (Tr=0.5/1/2/4/8/12/16/20/24/OFF)
3. Instantaneous Setting Knob (Isd=1.5/2/2.5/3/4/5/6/8/10/OFF)
4. (I2t on: Tsd=0.1/0.2/0.3/0.4; I2t off: Tsd=0/0.1/0.2/0.3/0.4)
5. Instantaneous Setting Knob (Ii=2/3/4/6/8/10/12/15/OFF)
6. Alarm indicator: Overload (red light)

**Protection**

Long-time												
Current setting(A)	Ir=Inx	0.4	0.45	0.5	0.6	0.63	0.7	0.8	0.9	1	OFF	
Time Delay (s)	Tr (s)	0.5	1	2	4	8	12	16	20	24	OFF	
	1.5xIr	8	16	32	64	128	192	256	320	384		
	6xIr	0.5	1	2	4	8	12	16	20	24		
Accuracy: ±20%	7.2xIr	0.35	0.7	1.39	2.78	5.56	8.3	11.1	13.9	16.7		
Short-time												
Current setting(A)	Accuracy: ±10%	Isd=Irx	1.5	2	2.5	3	4	5	6	8	10	OFF
Time Delay Tsd(s)	I²t off	0	0.1	0.2	0.3	0.4						
	I²t on		0.1	0.2	0.3	0.4						
Time Delay (ms) at 10xIr (I2t off or on)	Tsd(Max. resettable time)	20	80	140	230	350						
	Tsd(Max. trip time)	80	140	200	320	500						
Instantaneous												
Current setting(A)	Accuracy: ±10%	Ii=Irx	2	3	4	6	8	10	12	15	OFF	
Tripping time		60 ±20 ms										

Index

MCCB  
ELCB

ATS

ACB

MCB

SPD

MS

MMS



### Molded Case Circuit Breaker ( Electronic trip Unit)

Frame size (AF) (Inm)		100			160			250			
Type		BM100-HE	BM100-RE	BM100-UE	BM160-HE	BM160-RE	BM160-UE	BM250-HE	BM250-RE	BM250-UE	
Rated current In (A) at ambient temp. 40 °C		100			160			250			
Electronically adjustable current Ir (A)		40, 45, 50, 60, 70, 80, 90, 95, 100.			64, 72, 80, 96, 112, 128, 144, 152, 160.			100, 113, 125, 150, 175, 200, 225, 238, 250.			
Rated operational voltage Ue (V AC)		500			500			500			
Rated insulation voltage Ui (V)		690			690			690			
Rated impulse withstand voltage Uimp (kV)		8			8			8			
Number of poles (P)		3P / 4P			3P / 4P			3P / 4P			
Model		HE	RE	UE	HE	RE	UE	HE	RE	UE	
Rated breaking capacity Icu (kA)		50	70	85	50	70	85	50	70	85	
Dimensions (mm)	<p>(mm)</p>	a	105 / 140			105 / 140			105 / 140		
		b	165			165			165		
		c	86			86			86		
		ca	112			112			112		
		bb	126			126			126		
		aa	35			35			35		
Weight (kg)		2.5 / 3.0			2.5 / 3.0			2.5 / 3.0			
Endurance	Electrical life (10 thousand)	1,000			1,000			1,000			
	Mechanical life (10 thousand)	8,500			7,000			7,000			
Connection		Clamp terminal			Clamp terminal			Clamp terminal			
Trip unit		Electronic			Electronic			Electronic			
Trip button		Equipped			Equipped			Equipped			
Optional accessories	Alarm switch (AL)	<input type="radio"/>			<input type="radio"/>			<input type="radio"/>			
	Auxiliary switch (AX)	<input type="radio"/>			<input type="radio"/>			<input type="radio"/>			
	Shunt trip (SHT)	<input type="radio"/>			<input type="radio"/>			<input type="radio"/>			
	Under-voltage trip (UVT)	—			—			—			
	Lead wiring terminal (LT)	<input type="radio"/>			<input type="radio"/>			<input type="radio"/>			
	Motor operation device	<input type="radio"/>			<input type="radio"/>			<input type="radio"/>			
	Communication (COM)	<input type="radio"/>			<input type="radio"/>			<input type="radio"/>			
Communication (HUB)	<input type="radio"/>			<input type="radio"/>			<input type="radio"/>				

Note 1. Ics= 50% Icu

400			630			800			1000		1250	
BM400-HE	BM400-RE	BM400-UE	BM630-HE	BM630-RE	BM630-UE	BM800-SE	BM800-HE	BM800-RE	BM1000-SE	BM1000-HE	BM1250-SE	BM1250-HE
400			630			800			1000		1250	
160, 180, 200, 240, 280, 320, 360, 380, 400.			252, 284, 315, 378, 441, 504, 567, 600, 630.			320, 360, 400, 480, 560, 640, 720, 760, 800.			400, 450, 500, 600, 700, 800, 900, 950, 1000.		500, 563, 625, 750, 875, 1000, 1125, 1188, 1250.	
500			500			500			500		500	
690			690			690			690		690	
8			8			8			8		8	
3P / 4P			3P / 4P			3P / 4P			3P		3P	
HE	RE	UE	HE	RE	UE	SE	HE	RE	SE	HE	SE	HE
50	70	85	50	70	85	50	70	85	70	85	70	85
140 / 185			210 / 280			210 / 280			210		210	
257			275			275			406		406	
103			103			103			140		140	
144			155			155			190		190	
194			243			243			375		375	
44			70			70			70		70	
7 / 8			11.5 / 14.5			11.5 / 14.5			26		26	
1,000			1,000			500			500		500	
4,000			4,000			2,500			2,500		2,500	
Busbar			Busbar			Busbar			Busbar		Busbar	
Electronic			Electronic			Electronic			Electronic		Electronic	
Equipped			Equipped			Equipped			Equipped		Equipped	
○			○			○			○		○	
○			○			○			○		○	
○			○			○			—		—	
○			○			○			—		—	
—			—			—			—		—	
○			○			○			—		—	
○			○			○			—		—	
○			○			○			—		—	

Index

MCCB  
ELCB

ATS

ACB

MCB

SPD

MS





MMS

## Earth Leakage Circuit Breaker

Frame size (AF) (Inm)		50		100				
Model		BL50-SN		BL100-SN		BL100-HN		
Appearance								
Rated current In (A) at ambient temp. 40°C		15, 20, 30, 40, 50.		15, 20, 30, 40, 50, 60, 75, 100.		15, 20, 30, 40, 50, 60, 75, 100.		
Phase & wire (P)		1ø2W, 3ø3W.	3ø4W	1ø2W, 3ø3W.	3ø4W	1ø2W, 3ø3W.	3ø4W	
Number of poles (P)		3	4	3	4	3	4	
Rated voltage (VAC)		230, 400.		230, 400.		230, 400.		
High speed	Rated current sensitivity I $\Delta$ n AC type (mA)	30-100-500mA (adj) *15mA, *30mA, *100mA *100-300-500mA (adj)		30-100-500mA (adj) *15mA, *30mA, *100mA *100-300-500mA (adj)		30-100-500mA (adj) *15mA, *30mA, *100mA *100-300-500mA (adj)		
	Rated current sensitivity I $\Delta$ n A type (mA)	30-100-300-500mA(adj)		30-100-300-500mA(adj)		30-100-300-500mA(adj)		
	2I $\Delta$ n operating time (S)	0.1		0.1		0.1		
	5I $\Delta$ n operating time (S)	0.04		0.04		0.04		
Delay	Rated current sensitivity I $\Delta$ n AC type (mA)	100-300-500mA(adj)		100-300-500mA(adj)		100-300-500mA(adj)		
	Rated current sensitivity I $\Delta$ n A type (mA)	100-300-500-1000mA(adj)		100-300-500-1000mA(adj)		100-300-500-1000mA(adj)		
	2I $\Delta$ n operating time (S)	0.1- 0.4- 0.8- 2.0 adjustable		0.1- 0.4- 0.8- 2.0 adjustable		0.1- 0.4- 0.8- 2.0 adjustable		
	2I $\Delta$ n max. non-operating time (S)	0, 0.2, 0.4, 1.0		0, 0.2, 0.4, 1.0		0, 0.2, 0.4, 1.0		
Leakage detection mode		Mechanical push-button		Mechanical push-button		Mechanical push-button		
Dimensions		a	75	100	90	120	90	120
		b	130		155		155	
		c	68		68		68	
		ca	90		90		90	
		bb	111		132		132	
		aa	25		30		30	
		Weight (kg)		0.7	0.9	1.5	1.8	1.5
Rated breaking capacity (kA)	IEC 60947-2 EN 60947-2 CNS 14816-2	440V	7.5		10		25	
		380V	7.5		15		30	
		220V	10		25		50	
Connection		Clamp terminal		Clamp terminal		Clamp terminal		
Optional accessories	Alarm switch	(AL)	○		○		○	
	Auxiliary switch	(AX)	○		○		○	
	Shunt trip	(SHT)	○		○		○	
	Under-voltage trip	(UVT)	—		○		○	
	Rptary handle	(EH)	●		●		●	
	Terminal cover	(TC)	●		●		●	
	Leakage alarm module	(AM)	—		○		○	
	Box lug	(TL)	●		●		●	
Trip Unit		Hydraulic magnetic		Hydraulic magnetic		Hydraulic magnetic		
Tripping button		Equipped		Equipped		Equipped		

Note 1. "●" which can be installed by client, "○" which have to be installed by manufacturer. "—" which is not available.  
 2. Specify default rated current sensitivity when place the order.  
 3. Ics= 50% Icu  
 4. Adjustable thermal: 80%~100% In.  
 5. Specify, when order delay type rated current sensitivity 30-100-500mA.

80% ~ 100% Adj. (A)

160		250		400					
BL160-SN		BL250-SN		BL400-SN		BL400-HN		BL400-RN	
									
125, 140, 160.		175, 200, 225, 250.		250, 300, 350, 400.		250, 300, 350, 400.		250, 300, 350, 400.	
1ø2W, 3ø3W.	3ø4W	1ø2W, 3ø3W.	3ø4W	1ø2W, 3ø3W.	3ø4W	1ø2W, 3ø3W.	3ø4W	1ø2W, 3ø3W.	3ø4W
3	4	3	4	3	4	3	4	3	4
230, 400.		230, 400.		230, 400.		230, 400.		230, 400.	
30-100-500mA (adj) *15mA, *30mA, *100mA *100-300-500mA (adj)		30-100-500mA (adj) *15mA, *30mA, *100mA *100-300-500mA (adj)		30-100-500mA (adj) *15mA, *30mA, *100mA *100-300-500mA (adj)		30-100-500mA (adj) *15mA, *30mA, *100mA *100-300-500mA (adj)		30-100-500mA (adj) *15mA, *30mA, *100mA *100-300-500mA (adj)	
30-100-300-500mA(adj)		30-100-300-500mA(adj)		30-100-300-500mA(adj)		30-100-300-500mA(adj)		30-100-300-500mA(adj)	
0.1		0.1		0.1		0.1		0.1	
0.04		0.04		0.04		0.04		0.04	
100-300-500mA(adj)		100-300-500mA(adj)		100-300-500mA(adj)		100-300-500mA(adj)		100-300-500mA(adj)	
100-300-500-1000mA(adj)		100-300-500-1000mA(adj)		100-300-500-1000mA(adj)		100-300-500-1000mA(adj)		100-300-500-1000mA(adj)	
0.1- 0.4- 0.8- 2.0 adjustable		0.1- 0.4- 0.8- 2.0 adjustable		0.1- 0.4- 0.8- 2.0 adjustable		0.1- 0.4- 0.8- 2.0 adjustable		0.45- 1.0- 2.0 adjustable	
0, 0.2, 0.4, 1.0		0, 0.2, 0.4, 1.0		0, 0.2, 0.4, 1.0		0, 0.2, 0.4, 1.0		0.1, 0.5, 1.0	
Mechanical push-button		Mechanical push-button		Mechanical push-button		Mechanical push-button		Mechanical push-button	
105	140	105	140	140	185	140	185	140	185
165		165		257		257		257	
68		68		103		103		103	
92		92		155		155		155	
126		126		194		194		194	
35		35		44		44		44	
1.7	2.3	1.7	2.3	6.6	8.4	6.6	8.4	5.7	7.5
25		25		30		42		55	
30		30		35		50		70	
50		50		50		85		100	
Clamp terminal		Clamp terminal		Busbar		Busbar		Busbar	
●		●		●		●		●	
●		●		●		●		●	
●		●		●		●		●	
●		●		●		●		●	
●		●		●		●		●	
●		●		●		●		●	
○		○		○		○		○	
●		●		●		●		●	
Adj. thermal Fixed magnetic		Adj. thermal Fixed magnetic		Thermal magnetic		Thermal magnetic		Thermal magnetic	
Equipped		Equipped		Equipped		Equipped		Equipped	

Index

MCCB  
ELCB

ATS

ACB

MCB

SPD

MS





MMS



## Earth Leakage Circuit Breaker

Frame size (AF) (Inm)		400		630				
Model		BL400-UN		BL630-HN		BL630-RN		
Appearance								
Rated current In (A) at ambient temp. 40°C		250, 300, 350, 400.		500, 630.		500, 630.		
Phase & wire (P)		1ø2W, 3ø3W.	3ø4W	1ø2W, 3ø3W.	3ø4W	1ø2W, 3ø3W.	3ø4W	
Number of poles (P)		3	4	3	4	3	4	
Rated voltage (VAC)		230, 400.		230, 400.		230, 400.		
High speed	Rated current sensitivity IΔn AC type (mA)	30-100-500mA (adj) *15mA, *30mA, *100mA *100-300-500mA (adj)		100-300-500mA (adj)		100-300-500mA (adj)		
	Rated current sensitivity IΔn A type (mA)	30-100-300-500mA(adj)		100-300-500-1000mA( adj)		100-300-500-1000mA( adj)		
	2IΔn operating time (S)	0.1		0.1		0.1		
	5IΔn operating time (S)	0.04		0.04		0.04		
Delay	Rated current sensitivity IΔn AC type (mA)	100-300-500mA(adj)		100-300-500mA(adj)		100-300-500mA(adj)		
	Rated current sensitivity IΔn A type (mA)	100-300-500-1000mA(adj)		100-300-500-1000mA(adj)		100-300-500-1000mA(adj)		
	2IΔn operating time (S)	0.45- 1.0- 2.0 adjustable		0.45- 1.0- 2.0 adjustable		0.45- 1.0- 2.0 adjustable		
	2IΔn max. non-operating time (S)	0.1, 0.5, 1.0		0.1, 0.5, 1.0		0.1, 0.5, 1.0		
Leakage detection mode		Mechanical push-button		Mechanical push-button		Mechanical push-button		
Dimensions		a	140	185	210	280	210	280
		b	257		257		257	
		c	103		103		103	
		ca	155		155		155	
		bb	194		243		243	
		aa	44		70		70	
Weight (kg)		5.7	7.5	10.0	13.0	10.0	13.0	
Rated breaking capacity (kA)	IEC 60947-2 EN 60947-2 CNS 14816-2 AC	440V	85	50	70	70	70	
		380V	85	50	70	70	70	
		Icu 220V	125	85	100	100	100	100
Connection		Busbar		Busbar		Busbar		
Optional accessories	Alarm switch (AL)	●		●		●		
	Auxiliary switch (AX)	●		●		●		
	Shunt trip (SHT)	●		●		●		
	Under-voltage trip (UVT)	●		●		●		
	Rotary handle (EH)	●		●		●		
	Terminal cover (TC)	●		●		●		
	Leakage alarm module (AM)	○		○		○		
	Box lug (TL)	●		●		●		
Trip Unit		Thermal magnetic		Fixed thermal Adj. magnetic		Fixed thermal Adj. magnetic		
Tripping button		Equipped		Equipped		Equipped		

Note 1. "●" which can be installed by client, "○" which have to be installed by manufacturer. "—" which is not available.  
 2. Specify default rated current sensitivity when place the order.  
 3. Ics= 50% Icu  
 4. Adjustable thermal: 80%~100% In.  
 5. Specify, when order delay type rated current sensitivity 30-100-500mA.

630		800					
BL630-UN		BL800-SN		BL800-HN		BL800-RN	
							
500, 630.		700, 800.		700, 800.		700, 800.	
1ø2W, 3ø3W.	3ø4W	1ø2W, 3ø3W.	3ø4W	1ø2W, 3ø3W.	3ø4W	1ø2W, 3ø3W.	3ø4W
3	4	3	4	3	4	3	4
230, 400.		230, 400.		230, 400.		230, 400.	
100-300-500mA (adj)		100-300-500mA (adj)		100-300-500mA (adj)		100-300-500mA (adj)	
100-300-500-1000mA (adj)		100-300-500-1000mA (adj)		100-300-500-1000mA (adj)		100-300-500-1000mA (adj)	
0.1		0.1		0.1		0.1	
0.04		0.04		0.04		0.04	
100-300-500mA(adj)		100-300-500mA(adj)		100-300-500mA(adj)		100-300-500mA(adj)	
100-300-500-1000mA(adj)		100-300-500-1000mA(adj)		100-300-500-1000mA(adj)		100-300-500-1000mA(adj)	
0.45- 1.0- 2.0 adjustable		0.45- 1.0- 2.0 adjustable		0.45- 1.0- 2.0 adjustable		0.45- 1.0- 2.0 adjustable	
0.1, 0.5, 1.0		0.1, 0.5, 1.0		0.1, 0.5, 1.0		0.1, 0.5, 1.0	
Mechanical push-button		Mechanical push-button		Mechanical push-button		Mechanical push-button	
210	280	210	280	210	280	210	280
257		257		257		257	
103		103		103		103	
155		155		155		155	
243		243		243		243	
70		70		70		70	
10.0	13.0	10.5	13.5	10.5	13.5	10.5	13.5
85		50		70		85	
100		50		70		100	
125		85		100		125	
Busbar		Busbar		Busbar		Busbar	
●		●		●		●	
●		●		●		●	
●		●		●		●	
●		●		●		●	
●		●		●		●	
●		●		●		●	
○		○		○		○	
●		●		●		●	
Fixed thermal Adj. magnetic		Fixed thermal Adj. magnetic		Fixed thermal Adj. magnetic		Fixed thermal Adj. magnetic	
Equipped		Equipped		Equipped		Equipped	

Index

MCCB  
ELCB

ATS

ACB

MCB

SPD

MS

MMS

**Bolt on type**

Frame (AF)		100			50	100			50	100			50	100		
Type		BP			BPH			BKH			BKS					
Appearance																
Rated Voltage (A.C) #1		110	220*	220	110	220*	220	110/220*	380	110/220*	220					
Rated Current In (A) At Ambient Temp. 40°C		10*, 15, 20, 30, 40, 50, 60, 75, 100.			15, 20, 30, 40, 50.			15, 20, 30, 40, 50, 60, 75, 100.			15, 20, 30, 40, 50, 60, 75, 100.					
Number of poles (P)		1	2	3	1	2	3	1	2	3	1	2	3			
Dimensions		a	25	50	75	25	50	75	25	50	75	25	50	75		
	b	95			95			95			95					
	c	58.5			58.5			58.5			58.5					
	ca	77.5			77.5			77.5			77.5					
	bb	100			100			100			100					
	aa	0	25	50	0	25	50	0	25	50	0	25	50			
Weight (kg)		0.15	0.31	0.46	0.2	0.4	0.6	0.22	0.44	0.66	0.22	0.44	0.66			
Rated Breaking Capacity (kA) CNS 14816-2 Icu AC #2 #3	110V / 120V*	5	—	—	10	—	—	15	—	—	25/22**	—				
	220V / 240V*	—	5***	5	—	10	10	10	15	—	—	25/22**				
	380V / 400V*	—	—	—	—	—	—	—	10	—	—	—				
Trip Unit		Thermal Magnetic			Thermal Magnetic			Thermal Magnetic			Thermal Magnetic					

**Plug in type**

Frame (AF)		50			100			50			100		
Type		BL			BLH			BLS			BKL		
Appearance													
Rated Voltage (A.C) #1		110/220*	220	110/220*	220	220	110/220*	380					
Rated Current In (A) At Ambient Temp. 40°C		15, 20, 30, 40, 50.	15, 20, 30, 40, 50, 60, 75, 100.	15, 20, 30, 40, 50.	15, 20, 30, 40, 50.	60, 75, 100.	15, 20, 30, 40, 50.	15, 20, 30, 40, 50, 60, 75, 100.					
Number of poles (P)		1	2	3	1	2	3	2	3	1	2	3	
Dimensions		a	25	50	75	25	50	75	50	75	25	50	75
	b	74			74			74			79		
	c	60.5			60.5			60.5			61		
	ca	74			74			74			77.5		
	bb	—			—			—			—		
	aa	0	25	50	0	25	50	25	50	0	25	50	
Weight (kg)		0.13	0.26	0.39	0.13	0.26	0.39	0.33	0.53	0.18	0.36	0.54	
Rated Breaking Capacity (kA) CNS 14816-2 Icu AC	110V / 120V*	5	—	—	10	—	—	—	—	15	—		
	220V / 240V*	—	5	—	—	10	—	10	—	10	15		
	380V / 400V*	—	—	—	—	—	—	—	—	—	10		
Trip Unit		Thermal Magnetic			Thermal Magnetic			Thermal Magnetic			Thermal Magnetic		

Note 1. \*\* 1 phase 3 wiring; L-L: 220V, L-N: 110V.  
 2. \*\*\* Rated Breaking Capacity: asym/sym.  
 3. \*\*\*\* BP 1P 220V 5kA Rated Current:15, 20, 30, 40, 50A.

**Earth Leakage Circuit Breaker | Earth Leakage, Overload, and Short Circuit Protection**

Frame (AF)	50		50		50		50		50		
Type	BL-50L		BL-50UL		BLP-50L		BLP-50UL		BL-50H		
Appearance											
Rated Current In (A) At Ambient Temp. 40°C	15, 20, 30, 40, 50.										
Phase & Wire	1φ2W										
Number of poles (P)	2P1E	2P2E	2P1E	2P2E	2P1E	2P2E	2P1E	2P2E	2P1E	2P2E	
Rated Voltage (A.C.) #1.	110	220	220***	220	110	220	220***	220	220***	220/380	
Rated Current Sensitivity (mA) #2.	30, (100, 200, 300, 500)*				30				30, (100, 200, 300, 500)*		
Max. Operating Time (s)	≤0.1S										
Rated Breaking Capacity (kA) CNS 5422 Icu AC	110V	5	—	10	—	5	—	10	—	15	—
	220V	—	5	5	10	—	5	5	10	10	15
Dimensions  (mm)	a	25	50	25	50	25	50	25	50	50	75
	b	110				92				95	
	c	60				60.5				58.5	
	ca	78.4				78.4				77.5	
	bb	120				—				100	
	aa	0	25	0	25	0	25	0	25	25	50
Weight (kg)	0.22	0.39	0.22	0.39	0.2	0.34	0.2	0.34	0.4	0.58	
Trip Unit	Thermal Magnetic										
Earth Leakage Tripping Device	Mechanical										

Index

MCCB  
ELCB

ATS

ACB

MCB

SPD

MS

MMS

Frame (AF)	Earth Leakage, Overload Protection		Earth Leakage Protection	
	30		30	
Type	BL-KLF		BL-KF	
Appearance				
Rated Current In(A) At Ambient Temp. 40°C	15, 20, 30		15, 20, 30, 40	
Phase & Wire	1φ2W		1φ2W	
Poles (P)	2P1E	2P2E	2	
Rated Voltage (A.C.)	110~220		110~220	
Rated Current Sensitivity (mA) #2.	30		30, (100, 200, 300, 500)*	
Max. Operating Time (s)	≤0.1S		≤0.1S	
Rated Breaking Capacity (kA) CNS 5422 Icu AC	110V~220V	1.5	1.5, 2.5	
	380V~480V	—	—	
Dimensions  (mm)	a	66	90	
	b	70	70	
	c	42	42	
	ca	60	60	
	bb	59	59	
	aa	33	57	
Weight (kg)	0.2		0.25	
Trip Unit	Thermal Magnetic		—	
Earth Leakage Tripping Device	Mechanical		—	

Note 1. \*\*\* 3 phase 4 wiring, L-N: 220V  
2. \*\* Special order.

### Optional Accessories Installation Table

■ AL: Alarm Switch / AX: Auxiliary Switch / SHT: Shunt Trip / UVT: Under Voltage Trip

Model	Poles	AL	AX	SHT or UVT	AL+AX	AL+ SHT or UVT	AX+ SHT or UVT	AL+AX+ SHT or UVT
BM30-SN BM50-CN BM60-SN/HN BM63-SN/HN BM100-SN/MN	3P							-
BL50-SN	3P 4P			 (#1.)	-	-	-	-
BM60-HBN BM100-HN BM125-SN/HN	3P 4P			 (3P) (4P)		 (3P) (4P)	 (3P) (4P)	-
BL100-SN BL100-HN	3P 4P			 No UVT for 3P	-	 (#2.)	 (#2.)	-
BM100-HS BM160-HS BM250-HS	3P 4P			 (#1.)		 (#1.)	 (#1.)	-
BM100-BTD/STD/LTD BM125-LTD/HTA/RTA BM160-SN/HN/HTA/RTA BM250-SN/HN/HTA/RTA BMA125-STA/LTA/HTA BMA160-STA/LTA/HTA BMA250-STA/LTA/HTA	3P 4P							
BL160-SN BL250-SN/ CN	3P 4P				-	-	-	-
BM400-SN/HN/CN/RN/UN BMA400-LTA/HTA/RTA BM630s-STD/LTD/HTD/RTD BM630s-STA/LTA/HTA/RTA BMA630s-STD/LTD/HTD/RTD BMA630s-STA/LTA/HTA/RTA	3P 4P				 AX can be installed in AL position			
BL400-SN/HN/RN/UN	3P 4P				 AX can be installed in AL position			-
BM630-SN/HN/CN/RN/UN BM800-CN/SN/HN/RN BMA630-HTD/RTD/HTA/RTA/HED/RED BMA800-HTD/RTD/HTA/RTA/HED/RED	3P 4P				 AX can be installed in AL position			 AX can be installed in AL position
BL630-HN/RN/UN BL800-SN/HN/RN	3P 4P							
BM1000-HS BM1200-HS BM1600-HS	3P				-			-

2P, 125Af and below : Accessories are installed on the right side.

Note:

- Standard: AL and AX are installed on left side, SHT and UVT are installed on right side.
- SHT is equipped with coil anti-burn switch.
- BL series can not do right side installation.
- UVT of BM30-SN~BM100-HN can not install on its left side.
- #1 means have no UVT.
- #2 means only can apply to 4P breakers.

- : AL
- : AX
- : SHT or UVT

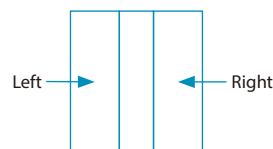

## Optional Accessories | Application Table

### Rotary Handle

TYPE	Poles	Model
EH-100N	3P~4P	BM30-SN, BM50-CN, BM60-SN/HN, BM63-SN/HN, BM100-SN/MN, BL50-SN
EH-100T	3P~4P	BM100-BTD/STD
EH-100L	3P~4P	BM100-LTD, BM125-LTD
EH-125T	2P~3P~4P	BM125-HTA/RTA
EH-125N	3P~4P	BM60-HBN, BM100-HN, BM125-SN/HN, BL100-SN/HN, BMA125-STA/LTA/HTA
EH-250N	3P~4P	BM160-SN*/HN, BM250-CN*/SN/HN, BL160-SN, BL250-SN
EH-250T	3P~4P	BM160-HTA/RTA, BMA160-STA/LTA/HTA, BM250-HTA/RTA, BMA250-STA/LTA/HTA
EH-400N	3P~4P	BM400-CN*/SN/HN/RN/UN, BL400-SN/HN/RN/UN, BMA400-LTA/HTA/RTA BM630s-STD/LTD/HTD/RTD/STA/LTA/HTA/RTA, BMA630s-STD/LTD/HTD/RTD/STA/LTA/HTA/RTA
EH-800N	3P~4P	BM630-SN/HN/RN/UN, BM800-CN/SN/HN/RN, BL630-HN/RN/UN, BL800-SN/HN/RN, BMA630-HTD/RTD/HTA/RTA/HED/RED, BMA800-HTD/RTD/HTA/RTA/HED/RED
EH-250H	3P~4P	BM100-HS, BM160-HS, BM250-HS

Note: \* indicates the value is can applied to 2P model.

### Extended Rotary Handle

TYPE	Poles	Model
MA-100N	3P~4P	BM30-SN, BM50-CN, BM60-SN/HN, BM63-SN/HN, BM100-SN/MN, BL50-SN
MA-100T	3P~4P	BM100-BTD/STD
MA-100L	3P~4P	BM100-LTD, BM125-LTD
MA-125T	2P~3P~4P	BM125-HTA/RTA, BMA125-STA/LTA
MA-125N	3P~4P	BM60-HBN, BM100-HN, BM125-SN/HN, BL100-SN/HN, BMA125-STA/LTA/HTA
MA-250N	3P~4P	BM160-SN/HN, BM250-SN/HN, BMA125-STA/LTA/HTA, BMA250-STA/LTA/HTA, BL160-SN, BL250-SN
MA-250T	3P~4P	BM160-HTA/RTA, BMA160-STA/LTA/HTA, BM250-HTA/RTA, BMA250-STA/LTA/HTA
MA-400N	3P~4P	BM400-SN/HN/RN/UN, BL400-SN/HN/RN/UN, BMA400-LTA/HTA/RTA BM630s-STD/LTD/HTD/RTD/STA/LTA/HTA/RTA, BMA630s-STD/LTD/HTD/RTD/STA/LTA/HTA/RTA
MA-800N	3P~4P	BM630-SN/HN/RN/UN, BM800-CN/SN/HN/RN, BL630-HN/RN/UN, BL800-SN/HN/RN, BMA630-HTD/RTD/HTA/RTA/HED/RED, BMA800-HTD/RTD/HTA/RTA/HED/RED
MA-250H	3P~4P	BM100-HS, BM160-HS, BM250-HS

### Terminal Cover

TYPE	Poles	Long cover	Short cover	Model
TC-30N	2	TC30CN2P	—	BM30-CN
	3	TC30CN3P	—	
TC-100N	2	TC100N2P-K	TCS100N2P-K	BM30-SN, BM50-CN, BM60/63-SN/HN, BM100-MN/SN BL50-SN, BM100-BTD/STD, BM100/125-LTD
	3	TC100N3P-K	TCS100N3P-K	
	4	TC100N4P-K	TCS100N4P-K	
TC-125N	2	TC125N2P-K	TCS125N2P-K	BM60-HBN BM100-HN, BM125-SN/HN, BL100-SN/HN
	3	TC125N3P-K	TCS125N3P-K	
	4	TC125N4P	TCS125N4P	
TC-125A	2~3	TC125A3P-K	TCS125A3P-K	BM125-HTA/RTA, BMA125-STA/LTA/HTA
	4	TC125A4P-K	TCS125A4P-K	
TC-250N	3	TC250N3P-K	—	BM160-SN/HN, BM250-CN/SN/HN, BM160/250-HTA/RTA BMA160/250-STA/LTA/HTA, BL160-SN, BL250-SN
	4	TC250N4P-K	—	
TC-250H	3	TC250H3P	—	BM100-HS, BM160/250-HS
TC-400N	3	TC400N3P	—	BM400-CN/SN/HN/RN/UN, BM630s-STD/LTD/HTD/RTD BM630s-STA/LTA/HTA/RTA, BMA400-LTA/HTA/RTA BMA400-HTD/RTD/HMF/RMF, BMA630s-STD/LTD/HTD/RTD BMA630s-STA/LTA/HTA/RTA, BL400-SN/HN/RN/UN
	4	TC400N4P	—	
TC-630N	3	TC630N3P	—	BM630-CN/SN/HN/UN/RN, BM800-CN/SN/HN/RN BM630-HE/RE/UE, BM800-SE/HE/RE BMA630-HTD/RTD/HTA/RTA, BMA800-HTD/RTD/HTA/RTA BMA630-HED/RED, BMA800-HED/RED, BL630-HN/RN/UN, BL800-SN/HN/RN
	4	TC630N4P	—	

### Motor Operation Device

TYPE	Poles	Model
MT-100N	3P~4P	BM30-SN, BM50-CN, BM60-SN/HN, BM63-SN/HN, BM100-SN/MN, BL50-SN
MT-125N	3P~4P	BM60-HBN, BM100-HN, BM125-SN/HN, BL100-SN/HN, BMA125-STA/LTA/RTA
MT-250N	3P~4P	BM160-SN/HN, BM250-SN/HN, BL160-SN, BL250-SN, BMA160-STA/LTA/HTA, BMA250-STA/LTA/HTA
MT-400N	3P~4P	BM400-SN/HN/RN/UN, BL400-SN/HN/RN/UN, BMA400-LTA/HTA/RTA BM630s-STD/LTD/HTD/RTD/STA/LTA/HTA/RTA BMA630s-STD/LTD/HTD/RTD/STA/LTA/HTA/RTA
MT-800N	3P~4P	BM630-SN/HN/RN/UN, BM800-CN/SN/HN/RN, BL630-HN/RN/UN, BL800-SN/HN/RN, BMA630-HTD/RTD/HTA/RTA/HED/RED, BMA800-HTD/RTD/HTA/RTA/HED/RED
MT-250E	3P~4P	BM100-HS, BM160-HS, BM250-HS

Note: \* Applicable voltage: ① DC 24V ② AC 110V/ DC 110V ③ AC 230V/ DC 220V

### Rear Connection

TYPE	Poles	Model
PGI-100N50	3P	BM30-SN, BM50-CN, BM60-SN/HN, BM63-SN/HN, BL50-SN (50A and below), BM50-CN
PGI-100N	3P	BM60-SN/HN, BM100-SN/MN (60A and below)
PGI-125N50	3P	BM60-HBN, BM100-HN, BM125-SN/HN, BL100-SN/HN (50A and below)
PGI-125M	4P	BM100-HN, BM125-SN, BL100-SN/HN (50A and below)
PGI-125M	2P~3P~4P	BM125-HTA/RTA
PGI-125N	3P	BM60-HBN, BM100-HN, BM125-SN, BL100-SN/HN (60A and above)
PGI-125N	4P	BM100-HN, BM125-SN, BL100-SN/HN (60A and above)
PGI-250N	3P~4P	BM160-SN/HN, BM160-HTA/RTA, BM250-SN/HN, BM250-HTA/RTA, BL160-SN, BL250-SN
PGI-400N	3P~4P	BM400-SN/HN/RN/UN, BL400-SN/HN/RN/UN, BM630s-STD/LTD/HTD/RTD/STA/LTA/HTA/RTA, BMA630s-STD/LTD/HTD/RTD/STA/LTA/HTA/RTA
PGI-800N	3P~4P	BM630-SN/HN/RN/UN, BM800-CN/SN/HN/RN, BL630-HN/RN/UN, BL800-SN/HN/RN
PGI-BM250	3P	BM100-HS, BM160-HS, BM250-HS

### Locking Device

TYPE	Poles	Model
FHL-250M	2P~3P~4P	BM125-HTA/RTA, BMA125-STA/LTA/HTA
	3P~4P	BM160/250-HN/HTA/RTA/SN, BM250-CN, BMA160/250-STA/LTA/HTA, *BL160/250-SN
FHL-400M	3P~4P	BM400-CN/SN/HN/RN/UN, BM400-HE/RE/UE, BMA400-LTA/HTA/RTA, BMA630s-STD/LTD/HTD/RTD/STA/LTA/HTA/RTA, BM630s-STD/LTD/HTD/RTD/STA/LTA/HTA/RTA
FHL-800M	3P~4P	BM630-SN/HN/RN/UN, BM800-CN/SN/HN/RN, BM630-HE/RE/UE, BM800-SE/HE/RE, BMA630-HED/RED, BMA800-HED/RED, BMA630/800-HTD/RTD

## Optional Accessories | Dimensions

### Rotary Handle

Type	Poles	fig.1				fig.2			fig.3		
		A	B	C	D	E	F	G	H	J	K
EH-100N	3P, 4P	104	105	39	44	90	78	10	25	111	M4 or ø5
EH-100T	3P, 4P	104	105	39	44	90	78	10	25	111	
EH-100L	3P, 4P	104	105	39	44	90	78	10	35	126	
EH-125N	3P, 4P	104	105	39	44	90	78	10	30	132	
EH-250N	3P, 4P	104	105	39	44	90	78	10	35	126	
EH-250H	3P, 4P	104	125	39	44	90	78	10	35	126.5	
EH-400N	3P, 4P	150	173	60	77	108	112	10	44	194	
EH-800N	3P, 4P	150	173	60	77	108	112	10	70	243	

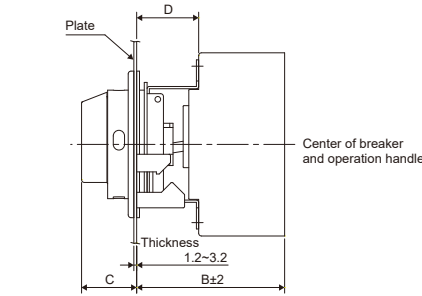
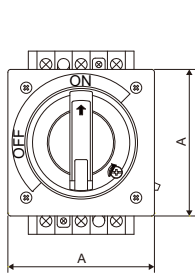
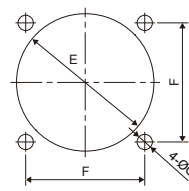
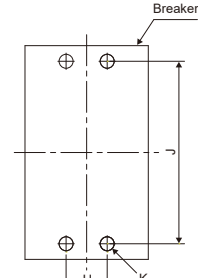

Fig. 1



Panel Dimension  
Fig. 2



Breaker Dimension  
Fig. 3

Note: 1. Optional for dust and water protection.

### Extended Rotary Handle

Type	Dimensions (mm)					Screw
	A	B	C	D	Y	
MA-100N	111	25	125	229	+8	M4x80
MA-100T	111	25	125	229	0	M4x75
MA-100L	111	25	125	229	0	M4x75
MA-125N	114	30	125	229	+8	M4x80
MA-250N	126	35	125	229	0	ST3x10
MA-250H	126	35	143	247	0	M4x50
MA-400N	221	44	190	290	+10	M5x50
MA-800N	242	70	190	290	+10	M6x125 & M6x12

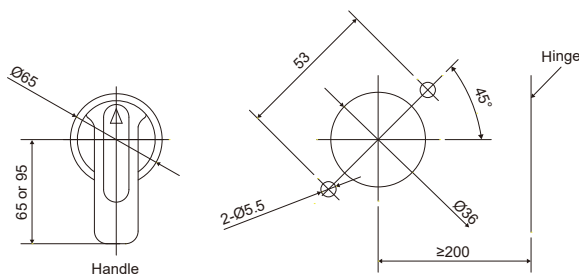
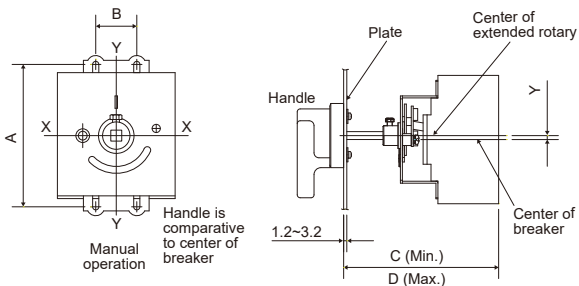

### Motor Operation Device

Type	Dimensions (mm)						
	A	B	d	H	K	L	W
MT-100N	25	111	ø4.5	16.5	79	102	74
MT-125N	30	132	ø4.5	15	77	116	90
MT-250N	30	126	ø4.5	15	77	116	90
MT-400N	44	194	ø4.5	36	115	176	130
MT-800N	70	234	ø4.5	36	115	176	130
MT-250E	30	126	ø4.5	15	77	116	90

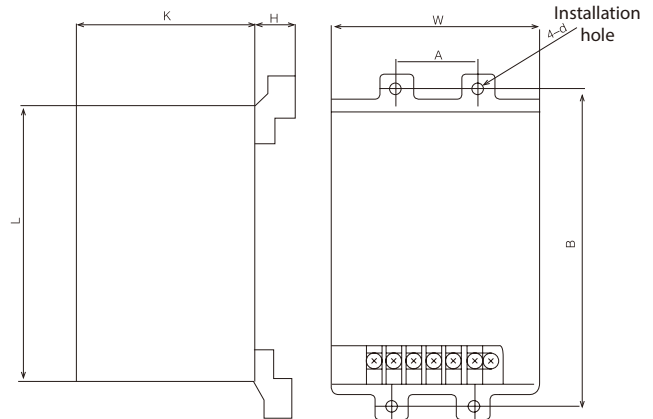

■ Rear Connection

Type	Poles	Dimensions (mm)																Connect Direction			
		A	A1	B	B1	C	D	D1	E	F	G	H	H1	J	K	K1	K2	L	M	Horizontal	Vertical
PGI-100N	3	74	50	24	58	90	ø5	/	116	M10	9.5	28	12	M10	/	62	122	50	M4	⊙	⊙
	4	99	75															75			
PGI-125N	3	92	60	30	70	104	ø6	/	134	M10	13	26	16	M10	/	62	122	60	M5	⊙	⊙
	4	122	90															90			
PGI-250N	3	107	70	38	76	106	ø6	ø10	144	25	13	34	15	6	/	79	134	70	M5	⊙	⊙
	4	142	105															105			
PGI-400N	3	137	44	50	135	175	ø10	ø13	225	28	18	40	24	8	120	79	/	44	M8	⊙	⊙
	4	181	88															88			
PGI-800N	3	212	140	57	143	185	ø10	ø13	243	44	17	53	20	11	/	146	/	140	M8	⊙	⊙
	4	282	210															210			

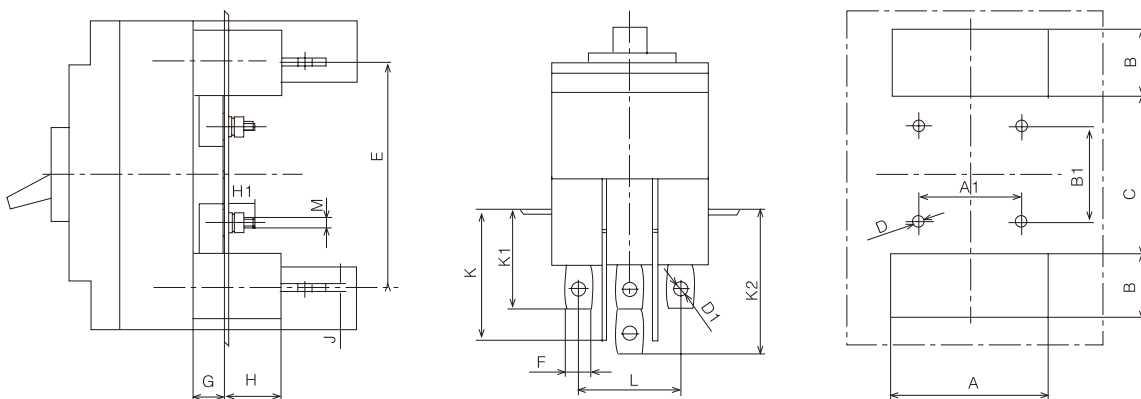

■ Rear Connection

Type	Poles	Dimensions (mm)																Connect Direction			
		A	A1	B	B1	C	D	D1	E	F	G	H	H1	J	K	K1	K2	L	M	Horizontal	Vertical
PGI-BM250	3	107	70	38	76	106	ø6	ø10	144	25	13	34	15	6	/	79	134	70	M5	⊙	⊙

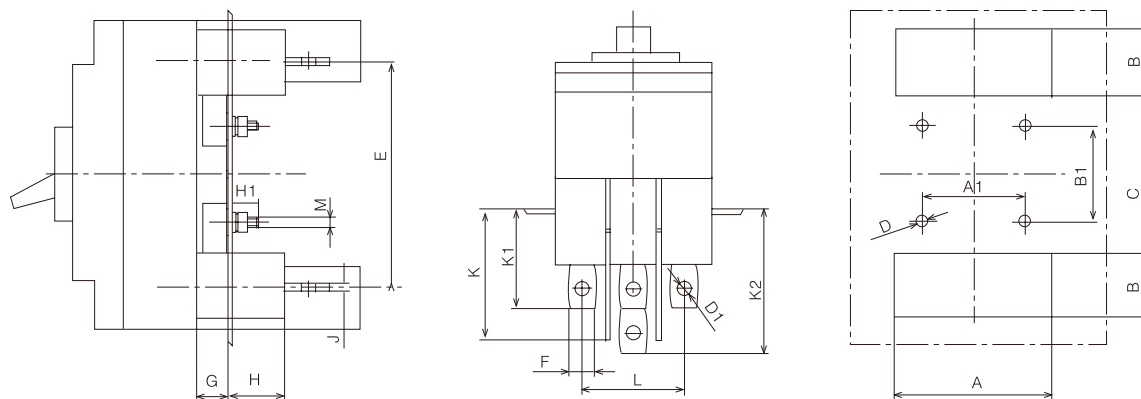

Index

MCCB  
ELCB

ATS

ACB

MCB

SPD

MS

MMS





## ATS (Automatic Transfer Switches)

### A. PC Class

Frame size	63			125			250			500		
Insulation Voltage, Ui	AC800V											
Rated Impulse Withstand Voltage, Uimp	12kV											
Rated Voltage, Ue	2P: AC220 / 230 / 240V 3/4P: AC380 / 400 / 415V											
Control Voltage , Us	AC220 / 230 / 240V, 50/60Hz											
Rated Current, In (A)	16, 20 , 25, 32, 40, 50, 63			80, 100, 125			160, 200, 225, 250			350, 400, 500		
Pole	2	3	4	2	3	4	2	3	4	2	3	4
Operation current (A)	AC220/230 /240V			3			3			5		
Tripping current (A)	AC220/230 /240V			1			1			1.4		
Rated condition short circuit current (fuse)	100kA			100kA			120kA			120kA		
Rated condition short circuit current (breaker)	50kA			50kA			65kA			65kA		
Making and Breaking Capacity	AC-33B, DC-33B											
Switching time	I -> II			≤1s								
	II -> I											
Endurance	Electrical: 6000 Mechanical: 20000											
Switching frequency	120 times / hr											
Auxiliary switch	2NO2NC on both source AC110V, 5A AC220V, 3A DC220V, 0.2A											

Note : AC-33A: Making & Breaking: 10Ie, cosφ=0.35  
 AC-33B: Making & Breaking: 10Ie, cosφ=0.35 (Ie≤100A, cosφ=0.45)  
 DC-33B: Making & Breaking: 4Ie, L/R=2.5ms



### ATS Controller Specification

#### • XST-5

Type	Standard
Poles	2 / 3 / 4
Rated operation voltage (V)	AC380 / 220 AC400 / 230 AC415 / 240
Rated operation frequency (Hz)	50 / 60
Operation voltage (V)	165~300 (Phase voltage)
Operation temperature (°C)	-25 ~ 60
Optional functions	—

800		1250		2500		5000	
AC800V							
12kV							
AC400V							
AC220V, 50Hz							
630, 800		1000, 1250		1600, 2000, 2500		3200, 4000, 5000	
3	4	3	4	3	4	3	4
6	6	6	8	8	9	18	20
2							
120kA		120kA		—		200kA	
50kA		50kA		50kA		—	
AC-33B, DC-33B						AC-33A, DC-33B	
≤1s							
Electrical: 6000 Mechanical: 10000							
120 times / hr							
2NO2NC on both source AC110V, 5A AC220V, 3A DC220V, 0.2A							

Index

MCCB  
ELCB

ATS

ACB

MCB

SPD

MS

MMS



## ATS Controller Specification

### • XST-6

Type	Multifunction
Poles	2 / 3 / 4
Rated operation voltage (V)	AC380 / 220 AC400 / 230 AC415 / 240
Rated operation frequency (Hz)	50 / 60
Operation voltage (V)	165~300 (Phase voltage)
Operation temperature (°C)	-25 ~ 60
Optional functions	Current measurement + communication

BO

33



(Controller voltage: AC 220V)

## ATS (Automatic Transfer Switches)

### A. MCCB Type

Type	Pole	Rated current In (A)	Rated Breaking Capacity Sym r.m.s. (kA) IEC 60947-2 AC Icu	
			220V	380V
BS100SN	3P, 4P	10, 15, 20, 30, 40, 50, 60, 75, 100.	25	15
BS100HN	3P, 4P		50	30
BS250SN	3P, 4P	125, 150, 175, 200, 225, 250.	50	30
BS400SN	3P, 4P		50	35
BS400HN	3P, 4P	250, 300, 350, 400.	85	50
BS630SN	3P, 4P		50	35
BS630HN	3P, 4P	500, 600, 630.	85	50
BS800SN	3P, 4P		700, 800.	85
BS1000HS	3P	1000	130	100
BS1200HS	3P	1200	130	100
BS1600HS	3P	1400, 1600.	130	100

Note: 1. Standard: IEC 60947-2  
 2. Special breaking capacity, please contact sales representative.  
 3. BS225SN rated current 250A is optional order.

Index

MCCB  
ELCB

ATS

ACB

MCB

SPD

MS

MMS



### B. MS Type

Type	ATS Protection Switch	Rated current In (A)	Pole	Voltage
BS-MB	Miniature Circuit Breaker Protection Switch	20A	R, N	110V
			R, T	220V



## Air Circuit Breaker

Frame Size		1600AF		2000AF		2500AF		3200AF		4000AF		6300AF		6300		
Model		BW-1600		BW-2000		BWA-2500		BW-3200		BW-4000		BW-6300		BW-6300		
Rated Current, In		400/630/ 800/1000	1250/ 1600	630/ 800/1000	1250/ 1600/2000	400/630/800/ 1000/1250/ 1600/2000	2500	2000/ 2500	3200	4000	5000	6300	4000/ 5000	6300		
Pole		3P / 4P		3P / 4P		3P / 4P		3P / 4P		3P / 4P		3P / 4P		3P / 4P		
Frequency (Hz)		50 / 60HZ		50 / 60HZ		50/60HZ		50 / 60HZ		50 / 60HZ		50 / 60HZ		50 / 60HZ		
Rated Voltage, Ue		AC690V		AC690V		AC 400/415/690V		AC690V		AC690V		AC690V		AC380 / 400 / 415, AC690		
Rated Impulse Withstand Voltage, Uimp		12kV		12kV		12kV		12kV		12kV		12kV		12kV		
Insulation Voltage, Ui		AC1000V		AC1000V		AC1000V		AC1000V		AC1000V		AC1000V		AC1000V		
Rated Current of Neutral (%)		100%In		100%In		100%In		100%In		100%In		100%In		100%In		
Breaking Capacity	Model	SN	HS	HN	H	HS	HN	HS	HN	HS	HN	HS	HN			
	Icu / Ics (kA)	690V	50/50	50/50	55/55	65 / 65	60/50	55/55	60/50	55/55	85/85	85				
		380/400/415V	65/65	80/50	85/85	85 / 85	100/65	100/100	100/65	100/100	120/100	120				
		240V	—	80/50	85/85	—	100/65	100/100	100/65	100/100	120/100	-				
	Icw (kA) 1sec	400/415V	50	50	65	85	65	85	65	85	100	100				
690V		50	50	65	65	65	65	65	75	85	85					
Operating time (ms)	Max. total breaking time	≤ 30		40		40		40		40		40	40	40		
	Max. closing time	≤ 70		80		80		80		80		80	80	80		
Endurance	Mechanical	With maintenance	20,000		20,000		30000		20,000		20,000		10,000	10,000	13000	
		Without maintenance	15,000		10,000		15000		10,000		10,000		2,500	2,500	6500	
	Electrical	With maintenance	10,000	8,000	15,000		8000		13,000		12,000		2,000	2,000	4000	
		Without maintenance	10,000	8,000	8,000		6000		6,500		6,000		500	500	4000	
Dimension HxWxD (mm)	Fixed Type	3P	312x265x201		402x362x332		397x365x364		402x422x332		402x422x377		—	—	402x800x377	
		4P	312x335x201		402x455x332		397x460x364		402x537x332		402x537x377		—	—	402x915x377	
	Drawout Type	3P	345x275x300		430x375x421		435x 405x448.5	435x 405x473	430x435x421		430x465x466		435x 842x505	435x 960x505	435x 842x495	435x 958x495
		4P	345x345x300		430x470x421		435x 500x448.5	435x 500x473	430x550x421		430x580x466		435x956x492		435x958x495	

Note: Icu/Ics/Icw for HS type only labeled 400V and 690V on the name plate, other voltage are for reference.

Index

MCCB  
ELCB

ATS

ACB

MCB

SPD

MS

MMS

## MCB (Miniature Circuit Breaker) | BHA Series

### Applications:

Applicable to the residential, industrial and commercial power distribution systems, provide circuit-control and protection on equipments against any impacts of overload, short-circuit and earth leakage.

- DIN rail TH 35mm
- Ambient temperature: -5°C~ +40°C



### BHA

#### • Overload, Short Circuit

BHA	2	2	C	32		
<b>Type</b>	<b>Rated short-circuit breaking capacity (kA)</b>	<b>Poles (P)</b>	<b>Tripping characteristics</b>	<b>Rated current In (A)</b>	<b>Standard</b>	<b>Mechanical life</b>
	<b>Rated voltage (V)</b>					
BHA	2: 4.5kA; 3: 6kA; 230/400V	1, 2, 3, 4	C type: 5~ 10In D type: 10~ 15In	1, 2, 3, 4, 5, 6, 10, 16, 20, 25, 32, 40, 50, 63.	IEC 60898	20,000 operations
BHA	125: 10kA 230/240V: 1P 400/415V: 2/3/4P	1, 2, 3, 4	8~12In	80, 100, 125	IEC 60947-2	10,000 operations
BHA	10kA 4: DC125V(1P) / DC250V(2P) 5: DC220V(1P) / DC440V(2P)	1, 2	DC Type	1, 2, 3, 4, 5, 6, 10, 16, 20, 25, 32, 40, 50, 63.	IEC 60947-2	20,000 operations
BHA-B	3: 6kA, 4: 10kA 240/415V	1, 2, 3, 4	B type: 3~5In C type: 5~10In D type: 10~15In	1, 2, 3, 4, 5, 6, 10, 16, 20, 25, 32, 40, 50, 63	IEC 60898IEC 60947-2	20,000 operations

• BHA5 can't be used in IT system



### BHL

#### • Overload, Short Circuit, Leakage

BHL	2	2	C	32	G
<b>Type</b>	<b>Rated short-circuit breaking capacity (kA)</b>	<b>Poles (P)</b>	<b>Tripping characteristics</b>	<b>Rated current In (A)</b>	<b>Optional function (2P)</b>
	<b>Rated voltage (V)</b>				
BHL	2: 4.5kA 230V: 2P ; 400V: 3P/4P	2, 3, 4	C type: 5~ 10In D type: 10~ 15In	1, 2, 3, 4, 5, 6, 10, 16, 20, 25, 32, 40, 50, 63.	Over-voltage protection (230V, internal built)
BHL	3: 6kA 230/400V	2, 3, 4	C type: 5~ 10In D type: 10~ 15In	1, 2, 3, 4, 5, 6, 10, 16, 20, 25, 32, 40, 50, 63.	Over-voltage protection (230V, internal built)

- Standard: IEC 61009
- Internal OVT over voltage range AC 280V ± 5%



### BHL-A

#### • Overload, Short Current, Leakage

BHL-A	3	1	C	32	A	30	G
<b>Type</b>	<b>Rated short-circuit breaking capacity (kA)</b>	<b>Poles (P)</b>	<b>Tripping characteristics</b>	<b>Rated current In (A)</b>	<b>Residual current type</b>	<b>Rated sensitivity current (mA)</b>	<b>Optional function (2P)</b>
	<b>Rated voltage (V)</b>						
BHL-A	2: 4.5kA; 3: 6kA 230V	1P+N	C type: 5~ 10In D type: 10~ 15In	6, 10, 16, 20, 25, 32, 40, 50, 63	A, AC	10, 30, 100, 300	Over-voltage protection (230V, internal built)
BHL-B	4L: 10kA AC 230/240V	1P+N	C type: 5~10In D type: 10~15In	6, 10, 16, 20, 25, 32, 40	A, AC	10, 30, 100mA	-



**BL-BF**

· Overload, Short Current, Leakage

BL-BF	V	15	015	20
↓	↓	↓	↓	↓
Model	Type	Rated current In (A)	Rated sensitivity current IΔn (mA)	Pole
BL-BF	V : RCCB L : RCBO C : MCB	15, 20, 30	000 : N/A (C Type) 015 : 15 (V/L Type) 030 : 30 (V/L Type)	20 : 2P0E (V type) 21 : 2P1E (C type) 22 : 2P2E (L type)



**BHR-A**

· Residual Current

BHR-A	42	25	A	030
↓	↓	↓	↓	↓
Type	Poles (P)	Rated current In (A)	Residual current Type	Rated sensitivity current IΔn (mA)
BHR-A	42: 2P 44: 4P	25, 32, 40, 63	A, AC	030: 30 100: 100 300: 300

**BHG**

· Disconnect Switch

BHG		2	32		
↓		↓	↓		
Type	Rated voltage (V)	Poles (P)	Rated current In (A)	Standard	Mechanical life
BHG	230/400V	1, 2, 3, 4	32A, 40A, 63A, 80A, 100A.	IEC 60947-3	50,000 operations



**BHN**

· N+L Overload, Short Circuit

BHN	2	1	C	32	
↓	↓	↓	↓	↓	
Type	Rated breaking capacity (kA)		Poles (P)	Tripping characteristics	Rated current In (A)
	Rated voltage (V)				
BHN	2: 4.5kA; 3: 6kA 230V		1P+N	C type: 5~ 10In	6, 10, 16, 20, 25, 32.



· Standard: IEC 60898

**BHZ**

· Over / Under Voltage Protective Device with Auto-reset

BHZ2	25							
↓	↓							
Type	Rated current In (A)	Over voltage		Under voltage		Operation time		Reset
		Operating value	Reset value	Operating value	Reset value	Over voltage	Under voltage	
BHZ2	25, 32, 40, 50, 63	> 275V	255V-265V 260	50V~160V	180V~190V 185	275V: 3-15s 300V: 1-3s 350V: 0.25-0.75s 400V: 0.1-0.2s	0.7s	30s±5s



· Standard: IEC 60898

Index

MCCB  
ELCB

ATS

ACB

MCB

SPD

MS

MMS

**BHK**

· Accessories

BHK	2						1		0					
↓	↓	↓	↓	↓	↓	↓	↓	↓	↓	↓	↓	↓	↓	↓
Type	Accessory Code						Installation		Control Voltage					
	1	2	3	4	5	6	1	2	0	1	2	3	4	5
	AL	AX	SHT	UVT	OVT	OUVT	Standard	Option	—	AC220~240V	DC48V	AC24~48V DC12~48V	AC12V	AC230~415V DC110~130V
BHK	AL						○		○					
		AX					○	○	○					
			SHT				○	○				○	○	○
				UVT			○	○		○	○			
					OVT		○	○	○					
					OUVT	○	○	○						

Note: 1. Standard: Attached on left side of breaker  
2. Option: Attached on left side of accessory

Index

MCCB  
ELCB

ATS

ACB

MCB

SPD

MS

MMS

Type	Auxiliary Contact		Width (mm)	Product Code
	AC/12			
AL Alarm Switch		1NO. 1NC 230V 6A 440V 3A	9	BHK11
AX Auxiliary Contact		1NO. 1NC 230V 6A 440V 3A	9	BHK21 BHK22

Type	Control Voltage		Width (mm)	Product Code
	V AC	V DC		
SHT Shunt Trip		12 24-48 230-415	12-48 110-130	18 BHK31 BHK32
UVT Under Voltage Trip		220-240	48	18 BHK41 BHK42

Type	Rated voltage	Current	Over voltage range	Trip time	Width (mm)	Product Code
OVT Over Voltage Trip		230V	15mA	280V±5%	≤0.2S	18 BHK51 BHK52

## MCB (Miniature Circuit Breaker) | RP Series

### Applications:

Applicable to power distribution, provide circuit to againsts overload, short-circuit and leakage.

- Windows display
- Din-rail TH35mm

### RPC

- Overload, Short Circuit

RPC	2	C	32
-----	---	---	----



Type	Poles (P)	Tripping characteristics	Rated current In(A)	Rated short-circuit breaking capacity(kA)	Standard	Mechanical life (times)
				Rated voltage (V)		
RPC	1, 2, 3, 4	B,C,D Type or 8~12In	1, 2, 3, 4, 5, 6,10, 16, 20, 25, 32, 40, 50, 63	6kA @240/415Vac	IEC60898-1, IEC60947-2	20000
RPC-H	1, 2, 3, 4	B,C,D Type or 8~12In	1, 2, 3, 4, 5, 6,10, 16, 20, 25, 32, 40, 50, 63	10kA @240/415Vac	IEC60898-1, IEC60947-2	20000

Index

MCCB  
ELCB

ATS

ACB

MCB

SPD

MS

MMS

### RPV

- Residual Current

RPV	1P+N	32	C	A	30
-----	------	----	---	---	----



Type	Poles (P)	Rated current In(A)	Rated conditional short-circuit current (I <sub>nc</sub> )	Residual current type	Rated residual current
RPV	1P+N 3P+N	16,20,25,32,40,63	6kA=C 10kA=H	A=A AC=C	10~300mA

· Note: Rated residual current 10 is below 40A

### RPL

- Overload, Short Current, Leakage

RPL	1P+N	C	32	AC
-----	------	---	----	----



Type	Poles (P)	Tripping characteristics	Rated current In(A)	Residual current type	Rated short-circuit breaking capacity(kA)	Rated residual current
					Rated voltage (V)	
RPL	1P+N	C,D Type	6, 10, 16, 20, 25, 32, 40, 50, 63	A~AC Type	6kA 2P: AC240V	10, 30, 100, 300mA



## Surge Protective Device | BHP Series



BHP	20	3P	R	320
-----	----	----	---	-----

Type	I <sub>max</sub> /I <sub>limp</sub> (kA)	Waveform (μs)	Pole (P)	Alarm auxiliary contact R: with Blank: without	U <sub>c</sub> (V)	U <sub>n</sub> (V)	U <sub>p</sub> (kV)	Waveform (μs)	I <sub>n</sub> (kA)	Connection wire diameter	
										L-N	PE
BHP20	20: 20kA	8/20	1P: 1P 1P1: 1P+1 2P: 2P 3P: 3P 3P1: 3P+1 4P: 4P	R	275	230/400	1.1	8/20	10	≧	≧
					320		1.2			2.5mm <sup>2</sup>	6mm <sup>2</sup>
BHP40	40: 40kA	8/20		R	275	230/400	1.3	8/20	20	≧	≧
					385		1.8			4mm <sup>2</sup>	16mm <sup>2</sup>
BHP80	80: 80kA	8/20		R	275	230/400	1.8	8/20	40	≧	≧
					385		2.1			10mm <sup>2</sup>	25mm <sup>2</sup>
BHP100	100: 100kA	8/20		R	275	230/400	2.1	8/20	60	≧	≧
					385		2.3			16mm <sup>2</sup>	25mm <sup>2</sup>
BHP250	250: 25kA	10/350		R	275	230/400	2.3	10/350	-	≧	≧
					440		2.3			25mm <sup>2</sup>	35mm <sup>2</sup>

To enable the surge protective device to work, please read the following note:

1. The grounding system type of the protected device and maximum operating voltage of the power grid U<sub>s</sub>. Max.
2. The impulse withstand voltage of the protected device.

Note: 1. BHP20, 40 are plug-in type; BHP80, 100, 250 are fixed type.  
2. The standard operation voltage U<sub>c</sub>(V) is below table. Max operation voltage U<sub>c</sub>(V): 660V.

### SPD Counter

Model	TAD-04-99
Rated Voltage	AC85~250V
Max. Count	99
Display	LED
Dimension (mm)	91X69X18

### Normal working conditions

- Frequency: the AC power frequency shall be 50/60Hz.
- Voltage: the voltage continuously supplied between the wiring terminals of the surge protective device shall not exceed its maximum continuous operating voltage U<sub>c</sub>.
- Altitude: less than 2,000m.
- Use and storage temperature: -Normal range: -5°C ~ +40°C;  
-Ultimate range: -40°C ~ +80°C;
- Humidity: Relative humidity 30%~90% under ambient temperature.

Magnetic Contactor / Motor Starter ◆ AC control



Model		9T	11	12T	15		
Type	Magnetic Contactor	Nonreversing	S-P9T	S-P11	S-P12T	S-P15	
		Reversing	S-2xP9T	S-2xP11	S-2xP12T	S-2xP15	
	Motor Starter	without enclosure	Nonreversing	MSO-P9T	MSO-P11	MSO-P12T	MSO-P15
			Reversing	MSO-2xP9T	MSO-2xP11	MSO-2xP12T	MSO-2xP15
		with enclosure	Nonreversing	MS-P9T	MS-P11	MS-P12T	MS-P15
			Reversing	MS-2xP9T	MS-2xP11	MS-2xP12T	MS-2xP15
		with enclosure (push button)	Nonreversing	MS-P9TPB	MS-P11PB	MS-P12TPB	MS-P15PB
	TOR	Standard	TH-P12ES	TH-P12ES	TH-P12ES	TH-P12ES	
		Differential	TH-P12ES PP	TH-P12ES PP	TH-P12ES PP	TH-P12ES PP	
	Rated Capacity	IEC 60947-4-1 EN 60947-4-1 DIN VDE 0660	3 Ø	240V	2.5/3/11	3.5/ 4.5/ 13	3.5/4.5/13
380/415V				4/5.5/9	5.5/ 7.5/ 12	5.5/7.5/12	7.5/ 10/ 18
440V				4/5.5/9	5.5/ 7.5/ 12	5.5/7.5/12	7.5/ 10/ 16
550V				4/5.5/7	5.5/ 7.5/ 9	7.5/10/12	7.5/ 10/ 13
660V				4/5.5/6	5.5/ 7.5/ 7	7.5/10/9	7.5/ 10/ 9
AC 3 (kW/HP/A)		Operation current (lth) AC1 (A)	25	20	25	25	
		Rated insulation voltage (V)	AC690	AC660	AC690	AC660	
UL 508 CSA-C22.2		1 Ø	100~120V	0.5/9.8	0.5/ 9.8	0.75/13.8	—
			200~240V	1.5/10	2/ 10	2/12	—
		3 Ø	200~240V	3/9.6	3/ 9.6	5/15.2	—
			380~480V	5/7.6	7.5/ 11	7.5/11	—
			550~600V	7.5/9	10/ 11	10/11	—
		Operation current (lth) AC1 (A)	25	24	25	—	
Rated insulation voltage (V)		AC600	AC600	AC600	—		
NEMA		—	0	—	0		
Auxiliary Contact	IEC 60947-5-1 EN 60947-5-1 GB14048.4	Contact	Standard	1No 1NC	1NO	1No 1NC	1NO
			Special	—	1NC	—	1NC
		AC 15	220V	1.6	1.6	1.6	1.6
			380V	0.95	0.95	0.95	0.95
	Operation current (lth) AC1 (A)	16	16	16	16		
	Contact class (UL)	A600 · Q300	A600, P600, Q300	A600 · Q300	—		
Electrical Life	AC3	1.6 Mil.	1.6 Mil.	1.6 Mil.	1.3 Mil.		
Mechanical Life		10 Mil.	10 Mil.	10 Mil.	10 Mil.		
Operation	(Time/Hour)	1200	1200	1200	1200		
Magnetic Contactor	Weight (kg)	0.34	0.33	0.34	0.33		
	Appearance Dimensions (W×H×D) (mm)	43×81×86	43×81×83.5	43×81×86	43×81×83.5		
	Installation Dimension (mm)						
	Mechanical Interlock	MPU-11	MPU-11	MPU-11	MPU-11		

Motor Starter

Index

MCCB  
ELCB

ATS

ACB

MCB

SPD

MS

MMS

BO

41

Magnetic Contactor / Motor Starter ◆ AC control

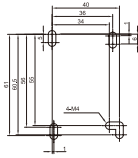
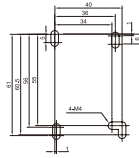
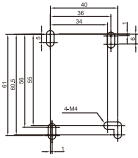
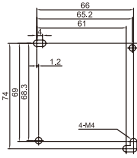

Model		16	21 (A)	25	30T		
Type	Magnetic Contactor	Nonreversing	S-P16	S-P21 (A)	S-P25	S-P30T	
		Reversing	S-2xP16	S-2xP21 (A)	S-2xP25	S-2xP30T	
	Motor Starter	without enclosure	Nonreversing	MSO-P16	MSO-P21 (A)	MSO-P25	MSO-P30T
			Reversing	MSO-2xP16	MSO-2xP21 (A)	MSO-2xP25	MSO-2xP30T
		with enclosure	Nonreversing	MS-P16	MS-P21 (A)	MS-P25	MS-P30T
			Reversing	MS-2xP16	MS-2xP21 (A)	MS-2xP25	MS-2xP30T
		with enclosure (push button)	Nonreversing	MS-P16PB	MS-P21PB (A)	MS-P25PB	MS-P30TPB
	TOR	Standard	TH-P20ES	TH-P20ES	TH-P20ES TA	TH-P20ES TA	
		Differential	TH-P20ES PP	TH-P20ES PP	TH-P20ES TAPP	TH-P20ES TAPP	
	Rated Capacity	IEC 60947-4-1 EN 60947-4-1 DIN VDE 0660	3 Ø	240V	4.5/ 6/ 18	5.5/ 7.5/ 24	6.5/ 8.5/ 26
380/415V				7.5/ 10/ 18	11/ 15/ 21	12/ 16/ 25	15/ 20/ 30
440V				7.5/ 10/ 16	11/ 15/ 21	12/ 16/ 23	15/ 20/ 27
550V				7.5/ 10/ 13	11/ 15/ 17	12/ 16/ 20	15/ 20/ 22
660V				7.5/ 10/ 9	11/ 15/ 14	12/ 16/ 16	15/ 20/ 18
AC 3 (kW/HP/A)		Continuous current (Ith) AC1 (A)	30	32	32	50	
		Rated insulation voltage (Ui) (V)	AC660	AC660	AC660	AC660	
UL 508 CSA-C22.2		1 Ø	100~120V	1/ 16	2/ 24	2/ 24	2/ 24
			200~240V	3/ 17	3/ 17	3/ 17	5/ 28
		3 Ø	200~240V	5/ 15.2	7.5/ 22	10/ 28	10/ 28
			380~480V	10/ 14	15/ 21	15/ 21	20/ 27
			550~600V	10/ 11	15/ 17	15/ 17	30/ 32
		AC3 (HP/A)	Operation current (Ith) AC1 (A)	30	35	40	50
Rated insulation voltage (Ui) (V)			AC600	AC600	AC600	AC600	
NEMA		0	1	1	2		
Auxiliary Contact	IEC 60947-5-1 EN 60947-5-1 GB14048.4	Contact	Standard	1NO 1NC	1NO 1NC (2NO 2NC)	1NO 1NC	2NO 2NC
			Special	—	—	—	—
		AC 15	220V	1.6	1.6	1.6	1.6
			380V	0.95	0.95	0.95	0.95
	Continuous current (Ith) AC1 (A)	16	16	16	16		
	Contact class (UL)	A600, Q300	A600, Q300	A600, Q300	A600, Q300		
Electrical Life	AC3	1.3 Mil.	1.3 Mil.	1.3 Mil.	1.3 Mil.		
Mechanical Life		10 Mil.	10 Mil.	10 Mil.	10 Mil.		
Operation	(Time/Hour)	1200	1200	1200	1200		
Magnetic Contactor	Weight (kg)	0.37	0.38	0.38	0.55		
	Appearance Dimensions (W×H×D) (mm)	53.5×81×83.5	53.5×81×83.5	53.5×81×83.5	73×95×93		
	Installation Dimension (mm)						
	Mechanical Interlock	MPU-21	MPU-21	MPU-21	MPU-11		

Motor Starter

Index

MCCB  
ELCB

ATS

ACB

MCB

SPD

MS

MMS

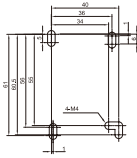
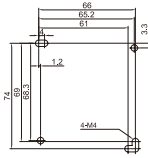
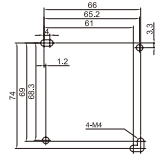
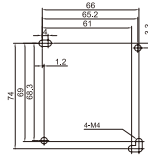
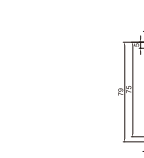
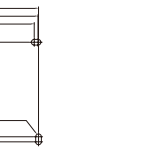

32T	35T	38T	40T	50T	60T
S-P32T	S-P35T	S-P38T	S-P40T	S-P50T	S-P60T
S-2xP32T	S-2xP35T	S-2xP38T	S-2xP40T	S-2xP50T	S-2xP60T
MSO-P32T	MSO-P35T	MSO-P38T	MSO-P40T	MSO-P50T	MSO-P60T
MSO-2xP32T	MSO-2xP35T	MSO-2xP38T	MSO-2xP40T	MSO-2xP50T	MSO-2xP60T
MS-P32T	MS-P35T	MS-P38T	MS-P40T	MS-P50T	MS-P60T
MS-2xP32T	MS-2xP35T	MS-2xP38T	MS-2xP40T	MS-2xP50T	MS-2xP60T
MS-P32TPB	MS-P35TPB	MS-P38TPB	MS-P40TPB	MS-P50TPB	MS-P60TPB
TH-P20ES TA	TH-P20ES TA	TH-P20ES TA	TH-P20ES TA	TH-P60ES	TH-P60ES TA
TH-P20ES TAPP	TH-P20ES TAPP	TH-P20ES TAPP	TH-P20ES TAPP	TH-P60ES PP	TH-P60ES TAPP
7.5/10/32	9/ 12.5/ 35	11/15/39	11/ 15/ 44	15/ 20/ 58	19/ 25/ 65
15/20/32	18.5/ 25/ 35	18.5/25/38	22/ 30/ 40	30/ 40/ 52	37/ 50/ 65
15/20/32	18.5/ 25/ 27	18.5/25/38	22/ 30/ 40	30/ 40/ 52	37/ 50/ 65
15/20/22	18.5/ 25/ 22	18.5/25/29	22/ 30/ 32	30/ 40/ 41	37/ 50/ 52
15/20/18	18.5/ 25/ 18	18.5/25/22	22/ 30/ 26	30/ 40/ 34	37/ 50/ 43
50	50	60	60	115	115
AC660	AC660	AC660	AC660	AC660	AC660
—	2/ 24	—	3/ 34	5/ 56	5/ 56
—	5/ 28	—	7.5/ 40	10/ 50	10/ 50
—	10/ 28	—	15/ 42	20/ 54	20/ 54
—	20/ 27	—	20/ 27	30/ 40	40/ 52
—	30/ 32	—	30/ 32	40/ 41	50/ 52
—	50	—	60	115	115
—	AC600	—	AC600	AC600	AC600
2	2	2	2	2	2
1NO 1NC	2NO 2NC	2NO 2NC	2NO 2NC	2NO 2NC	2NO 2NC
—	—	—	—	—	—
1.6	1.6	1.6	1.6	1.6	1.6
0.95	0.95	0.95	0.95	0.95	0.95
16	16	16	16	16	16
A600, Q300	A600, Q300	A600, Q300	A600, Q300	A600, Q300	A600, Q300
1.3 Mil.	1.3 Mil.	1.3 Mil.	1.3 Mil.	1.3 Mil.	1.3 Mil.
10 Mil.	10 Mil.	10 Mil.	10 Mil.	6 Mil.	6 Mil.
1200	1200	1200	1200	1200	1200
0.38	0.55	0.55	0.55	1.05	1.05
53.5x81x83.5	73x95x93	73x95x93	73x95x93	87.9x115x107	87.9x115x107
					
MPU-21	MPU-11	MPU-11	MPU-11	MPU-11	MPU-11

Index

MCCB  
ELCB

ATS

ACB

MCB

SPD

MS

MMS

BO

43

Magnetic Contactor / Motor Starter ◆ AC control

Motor Starter

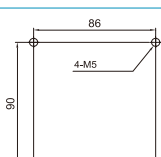
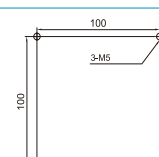
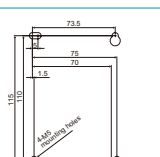
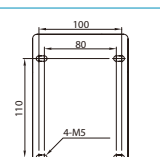

Model		80T	100T	100E	125T		
Type	Magnetic Contactor	Nonreversing	S-P80T	S-P100T	S-P100E	S-P125T	
		Reversing	S-2xP80T	S-2xP100T	S-2xP100E	S-2xP125T	
	Motor Starter	without enclosure	Nonreversing	MSO-P80T	MSO-P100T	MSO-E100	MSO-P125T
			Reversing	MSO-2xP80T	MSO-2xP100T	MSO-2xE100	MSO-2xP125T
		with enclosure	Nonreversing	MS-P80T	MS-P100T	MS-E100	MS-P125T
			Reversing	MS-2xP80T	MS-2xP100T	MS-2xE100	MS-2xP125T
		with enclosure (push button)	Nonreversing	–	–	MS-E100PB	–
	TOR	Standard	TH-P60ES TA	TH-P120 E(TA)	TH-E100E	TH-P120 E(TA)	
		Differential	TH-P60ES TAPP	TH-P120(TA)PP	TH-E100PP	TH-P120(TA)PP	
	Rated Capacity	IEC 60947-4-1 EN 60947-4-1 DIN VDE 0660	3 Ø	240V	22/ 30/ 80	30/ 40/ 105	30/ 40/ 105
380/415V				45/ 60/ 80	60/ 80/ 105	55/ 75/ 100	75/ 100/ 130
440V				45/ 60/ 75	60/ 80/ 105	60/ 80/ 100	75/ 100/ 130
550V				45/ 60/ 60	60/ 80/ 85	60/ 80/ 85	75/ 100/ 105
660V				45/ 60/ 50	60/ 80/ 70	60/ 80/ 70	75/ 100/ 90
AC 3 (kW/HP/A)		Continuous current (Ith) AC1 (A)	115	150	135	170	
		Rated insulation voltage (Ui) (V)	AC660	AC660	AC690	AC660	
UL 508 CSA-C22.2		1 Ø	100~120V	7.5/ 80	–	–	–
			200~240V	15/ 68	–	–	–
		3 Ø	200~240V	25/ 68	30/ 80	–	50/ 130
			380~480V	50/ 65	60/ 77	–	100/ 124
			550~600V	60/ 62	60/ 62	–	100/ 99
		Continuous current (Ith) AC1 (A)	115	150	–	170	
		Rated insulation voltage (Ui) (V)	AC600	AC600	–	AC600	
NEMA			3	3	–	3	
	Auxiliary Contact	IEC 60947-5-1 EN 60947-5-1 GB14048.4	Contact	Standard	2NO 2NC	2NO 2NC	1NO 1NC
Special				–	–	–	–
220V			1.6	1.6	3*	3.3	
380V			0.95	0.95	1.9	1.6	
Operation current (Ith) AC1 (A)		16	16	10	16		
Contact class (UL)	A600, Q300	A600, Q300	A600, Q300	A600, Q300			
Electrical Life	AC3	1.2 Mil.	1.2 Mil.	1 Mil.	1.2 Mil.		
Mechanical Life		6 Mil.	6 Mil.	6 Mil.	6 Mil.		
Operation	(Time/Hour)	1200	1200	1200	1200		
Magnetic Contactor	Weight (kg)	1.5	2.35	1.34	2.7		
	Appearance Dimensions (W×H×D) (mm)	100×142×116	120×116×128	85×125×127	106×152.5×140		
	Installation Dimension (mm)						
Mechanical Interlock		MPU-50	Assembled and adjusted by the factory.	MEU-11	MPU-125		

Note: Mark \* means the value is @240V

Index

MCCB  
ELCB

ATS

ACB

MCB

SPD

MS

MMS

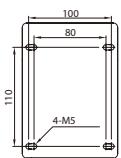
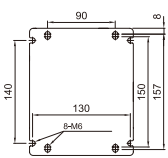
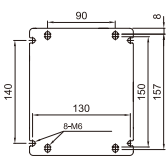
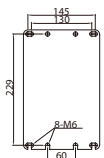
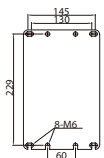

150T	200T	220T	300T	400T
S-P150T	S-P200T	S-P220T	S-P300T	S-P400T
S-2xP150T	S-2xP200T	S-2xP220T	S-2xP300T	S-2xP400T
MSO-P150T	MSO-P200T	MSO-P220T	MSO-P300T	MSO-P400T
MSO-2xP150T	MSO-2xP200T	MSO-2xP220T	MSO-2xP300T	MSO-2xP400T
MS-P150T	MS-P200T	MS-P220T	-	-
MS-2xP150T	MS-2xP200T	MS-2xP220T	-	-
-	-	-	-	-
TH-P120 E(TA)	TH-P220T E	TH-P220T E	TH-P400T E	TH-P400T E
TH-P120(TA)PP	TH-P220TPP	TH-P220TPP	TH-P400TPP	TH-P400TPP
45/ 60/ 165	55/ 75/ 200	65/ 85/ 225	90/ 125/ 300	110/ 150/ 400
90/ 125/ 160	110/ 150/ 190	120/ 160/ 220	160/ 220/ 300	220/ 300/ 400
90/ 125/ 160	110/ 150/ 190	120/ 160/ 220	185/ 250/ 300	250/ 340/ 400
90/ 125/ 130	110/ 150/ 150	132/ 180/ 180	185/ 250/ 263	250/ 340/ 360
90/ 125/ 110	110/ 150/ 125	132/ 180/ 150	200/ 300/ 220	280/ 380/ 305
225	275	315	500	635
AC660	AC660	AC660	AC1000	AC1000
-	-	-	-	-
-	-	-	-	-
60/ 154	75/ 192	75/ 192	100/ 248	125/ 312
125/ 156	150/ 180	150/ 180	200/ 240	250/ 302
125/ 125	150/ 144	150/ 144	200/ 192	300/ 289
225	275	315	500	635
AC600	AC600	AC600	AC1000	AC1000
3	4	4	5	5
2NO 2NC	2NO 2NC	2NO 2NC	2NO 2NC	2NO 2NC
-	-	-	-	-
3.3	3.3	3.3	3.3	3.3
1.6	1.6	1.6	1.6	1.6
16	16	16	10	10
A600, Q300	A600, Q300	A600, Q300	A600, Q300	A600, Q300
1.2 Mil.	1.2 Mil.	1.2 Mil.	1.2 Mil.	1.2 Mil.
6 Mil.	6 Mil.	6 Mil.	6 Mil.	6 Mil.
1200	1200	1200	1200	1200
2.7	4.35	4.35	9.75	9.75
106×152.5×140	138×185×159.5	138×185×159.5	164×246×196.5	164×246×196.5
				
MPU-125	MPU-125	MPU-125	MPU-125	MPU-125

Index

MCCB  
ELCB

ATS

ACB

MCB

SPD

MS

MMS

BO

45

**Magnetic Contactor / Motor Starter ◆ AC control**

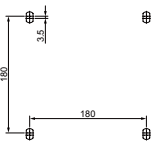
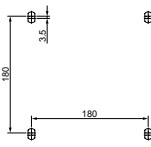
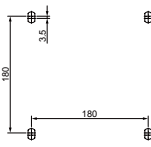
Model		630T	800T	1260T		
Magnetic Contactor	<b>Nonreversing</b>	S-P630T	S-P800T	S-P1260T		
	<b>Reversing</b>	S-2xP630T	S-2xP800T	S-2xP1260T		
Type	Motor Starter	without enclosure	Nonreversing	-	-	
			Reversing	-	-	
		with enclosure	Nonreversing	-	-	
			Reversing	-	-	
		with enclosure (push button)	Nonreversing	-	-	
TOR	Standard	TH-P600(E)	TH-P600(E)	-		
	Differential	TH-P600PP	TH-P600PP	-		
Rated Capacity	IEC 60947-4-1 EN 60947-4-1 DIN VDE 0660	3 Ø	<b>240V</b>	200 / 270 / 630	250 / 340 / 800	-
			<b>380/415V</b>	335 / 450 / 630	450 / 610 / 800	-
			<b>440V</b>	400 / 545 / 630	450 / 610 / 800	-
			<b>550V</b>	400 / 545 / 552	450 / 610 / 620	-
			<b>660V</b>	450 / 610 / 450	475 / 645 / 475	-
	AC 3 (kW/HP/A)	Continuous current (Ith) AC1 (A)	800	1000	1260	
		Rated insulation voltage (Ui) (V)	AC1000	AC1000	AC1000	
	UL 508 CSA-C22.2	1 Ø	100~120V	-	-	-
			200~240V	-	-	-
		3 Ø	200~240V	-	-	-
			380~480V	-	-	-
		AC3 (HP/A)	550~600V	-	-	-
Continuous current (Ith) AC1 (A)			-	-	-	
Rated insulation voltage (Ui) (V)	-	-	-			
<b>NEMA</b>		3	3	4		
Auxiliary Contact	IEC 60947-5-1 EN 60947-5-1 GB14048.4	Contact	Standard	2NO 2NC*	2NO 2NC*	-
			Special	-	-	-
			220V	-	-	-
			380V	-	-	-
	AC 15	Operation current (Ith) AC1 (A)	-	-	-	
Contact class (UL)	-	-	-			
<b>Electrical Life AC3</b>		500000	500000	-		
<b>Mechanical Life</b>		3000000	3000000	3000000		
<b>Operation (Time/Hour)</b>		-	-	-		
Magnetic Contactor	<b>Weight (kg)</b>	16.4	18.3	18.3		
	<b>Appearance Dimensions (W×H×D) (mm)</b>	309×304×255	309×338×255	309×338×255		
	<b>Installation Dimension (mm)</b>					
<b>Mechanical Interlock</b>		-	-	-		

\*Note: S-P630T and S-P800T is equipped with AP-22N (2NO2NC) when ordered, S-P1260T can be purchase separated.

# Magnetic Contactor / Motor Starter ◆ AC control

## Mini Contactor



## Thermal Overload Relay



Model		06	09			
Type	Magnetic Contactor	Nonreversing	S-P06	S-P09		
		Reversing	S-2xP06	S-2xP09		
	Motor Starter	without enclosure	Nonreversing	MSO-P06	MSO-P09	
			Reversing	—	—	
		with enclosure	Nonreversing	—	—	
			Reversing	—	—	
	with enclosure (push button)	Nonreversing	—	—		
	TOR	Standard	—	—		
		Differential	TH-P09PP	TH-P09PP		
	Rated Capacity	IEC 60947-4-1 EN 60947-4-1 DIN VDE 0660	3 Ø	240V	1.5/ 2/ 7.5	2.2/ 3/ 10.1
380/415V				3/ 4/ 6.6	4/ 5.5/ 9	
440V				3/ 4/ 6.5	4/ 5.5/ 8.5	
550V				3/ 4/ 5	4/ 5.5/ 6.5	
660V				3/ 4/ 4	4/ 5.5/ 5	
AC 3 (kW/HP/A)				Continuous Current (Ith) AC1 (A)	20	20
UL 508 CSA-C22.2 AC3 (HP/A)		1 Ø	100~120V	0.25/ 5.8	0.5/ 9.8	
			200~240V	1/ 8	1.5/ 10	
			3 Ø	200~240V	2/ 6.8	3/ 9.6
				380~480V	3/ 4.8	5/ 7.6
		550~600V	3/ 3.9	5/ 6.1		
			Continuous Current (Ith) AC1 (A)	20	20	
		Rated insulation voltage (V)	AC600	AC600		
		NEMA		00	00	
Auxiliary Contact	IEC 60947-5-1 EN 60947-5-1 GB14048.4 AC 15	Contact	Standard	1NO	1NO	
			Special	1NC	1NC	
			220V	3.3	3.3	
			380V	1.9	1.9	
	Continuous Current (Ith) AC1 (A)	10	10			
Contact class (UL)	A600	A600				
Electrical Life		AC3	1.6 Mil.	1.6 Mil.		
Mechanical Life			10 Mil.	10 Mil.		
Operation (Time/Hour)			1200	1200		
Magnetic Contactor	Weight (kg)		0.15	0.15		
	Appearance Dimensions (WxHxD) (mm)		46x58x51	46x58x51		
	Installation dimension (mm)					
Mechanical Interlock		—	—	—		

Type	09																							
Standard	Contact Assembled Type	—																						
	Independently Installed Type	—																						
With phase failure protection	Contact Assembled Type	TH-P09PP																						
	Independently Installed Type	—																						
Reset Mode		Manual / Automatic																						
Magnetic Contactor		S-P06, S-P09.																						
TOR Adjustment Range (A)		<table border="1"> <thead> <tr> <th>Rating (A)</th> <th>Range (A)</th> </tr> </thead> <tbody> <tr> <td>0.13</td> <td>0.1~0.16</td> </tr> <tr> <td>0.20</td> <td>0.16~0.24</td> </tr> <tr> <td>0.32</td> <td>0.24~0.4</td> </tr> <tr> <td>0.5</td> <td>0.4~0.6</td> </tr> <tr> <td>0.8</td> <td>0.6~1</td> </tr> <tr> <td>1.3</td> <td>1~1.6</td> </tr> <tr> <td>2.0</td> <td>1.6~2.4</td> </tr> <tr> <td>3.2</td> <td>2.4~4</td> </tr> <tr> <td>5</td> <td>4~6</td> </tr> <tr> <td>7.5</td> <td>6~9</td> </tr> </tbody> </table>	Rating (A)	Range (A)	0.13	0.1~0.16	0.20	0.16~0.24	0.32	0.24~0.4	0.5	0.4~0.6	0.8	0.6~1	1.3	1~1.6	2.0	1.6~2.4	3.2	2.4~4	5	4~6	7.5	6~9
Rating (A)	Range (A)																							
0.13	0.1~0.16																							
0.20	0.16~0.24																							
0.32	0.24~0.4																							
0.5	0.4~0.6																							
0.8	0.6~1																							
1.3	1~1.6																							
2.0	1.6~2.4																							
3.2	2.4~4																							
5	4~6																							
7.5	6~9																							
Auxiliary Contact		1NO 1NC																						
Weight		0.075																						
Dimensions (mm) (WxHxD)		45.5x64.8x50																						

## Coil Specification Table

◆ S-P06, S-P09						
Description	AC12V	AC24V	AC48V	AC110V	AC120V	AC220V
Coil rated specifications marking	12V 50Hz	24V 50Hz	48~50V 50Hz	100V 50Hz	110~120V 50Hz	200~220V 50Hz
	12V 60Hz	24V 60Hz	48~50V 60Hz	100~110V 60Hz	115~120V 60Hz	220V 60Hz
Description	AC230V	AC240V	AC380V	AC440V	AC480V	AC550V
Coil rated specifications marking	230V 50Hz	220~240V 50Hz	346~380V 50Hz	400V 50Hz	415~440V 50Hz	500V 50Hz
	230V 60Hz	240~260V 60Hz	380V 60Hz	400~440V 60Hz	460~480V 60Hz	500~550V 60Hz



Magnetic Contactor / Motor Starter ◆ DC control

Motor Starter



Model			06	09	11	16	21	
Magnetic Contactor	Nonreversing		SD-P06	SD-P09	SD-P11	SD-P16	SD-P21	
	Reversing		SD-2xP06	SD-2xP09	SD-2xP11	SD-2xP16	SD-2xP21	
Type	Motor Starter	without enclosure	Nonreversing	-	-	MDO-P11	MDO-P16	MDO-P21
			Reversing	-	-	MDO-2xP11	MDO-2xP16	MDO-2xP21
		with enclosure	Nonreversing	-	-	-	-	-
			Reversing	-	-	-	-	-
	with enclosure (push button)	Nonreversing	-	-	-	-	-	
	TOR	Standard	-	-	TH-P12ES	TH-P20ES	TH-P20ES	
Differential		TH-P09PP	TH-P09PP	TH-P12ES PP	TH-P20ES PP	TH-P20ES PP		
Rated Capacity	IEC 60947-4-1 EN 60947-4-1 DIN VDE 0660	3 ø	240V	1.5 / 2 / 6	2.2 / 3 / 9	3.5 / 4.5 / 13	4.5 / 6 / 18	5.5 / 7.5 / 24
			380/440V	3 / 4 / 6	4 / 5.5 / 9	5.5 / 7.5 / 12	7.5 / 10 / 18	11 / 15 / 21
			550V	3 / 4 / 6	4 / 5.5 / 9	5.5 / 7.5 / 9	7.5 / 10 / 13	11 / 15 / 17
			660V	-	-	5.5 / 7.5 / 7	7.5 / 10 / 9	11 / 15 / 14
	AC 3 (kW/HP/A)	Continuous Current (Ith)	AC1 (A)	20	20	20	30	32
		Rated insulation voltage (Ui)		690	690	660	660	660
	UL 508 CSA-C22.2	1 ø	110~120V	0.25 / 5.8	0.5 / 9.8	0.5 / 9.8	1 / 16	2 / 24
			220~240V	1 / 8	1.5 / 10	2 / 12	3 / 17	3 / 17
		3 ø	220~240V	2 / 6.8	3 / 9.6	3 / 9.6	5 / 15.2	7.5 / 22
			440~480V	3 / 4.8	5 / 7.6	7.5 / 11	10 / 14	15 / 21
550~600V			3 / 3.9	5 / 6.1	10 / 11	10 / 11	15 / 17	
AC3 (HP/A)		Continuous Current (Ith)	AC1 (A)	20	20	24	30	35
	Rated insulation voltage (Ui)		600	600	600	600	600	
NEMA			0	0	0	0	1	
Auxiliary Contact	Auxiliary contact	Standard	1NO	1NO	1NO	1NO1NC	1NO1NC	
		Special	1NC	1NC	1NC	-	-	
Control coil voltage DC (V)			24 / 36 / 48 / 110 / 220 / 240			12 / 24 / 30 / 48 / 72 / 110 / 125 / 220		
EC 60947-5-1 EN 60947-5-1	220V		3.3	3.3	1.6	1.6	1.6	
	380V		1.9	1.9	0.95	0.95	0.95	
Rated heating current (Ith)		(A)	10	10	16	16	16	
Contact class		(UL)	A600	A600	A600	A600	A600	
Performanc	Electrical life (AC3) (10 thousand)		120	120	120	120	120	
	Mechanical life (10 thousand)		600	600	600	600	600	
Weight		(kg)	0.43	0.43	0.33	0.37	0.38	
Appearance Dimensions (WxHxD)		(mm)	46 x 58 x 51	46 x 58 x 51	43 x 81 x 83.5	53.5x81x83.5	53.5x81x83.5	
Installation dimension		(mm)						

Index

MCCB  
ELCB

ATS

ACB

MCB



SPD

MS

MMS

**Capacitor Contactors**

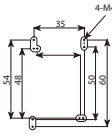
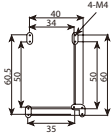
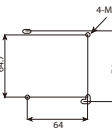
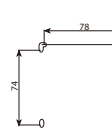
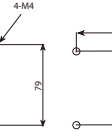
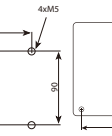
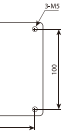

Type		SC-P12	SC-P16	SC-P20	SC-P25	SC-P33	SC-P45	SC-P60	SC-P70		
Rated insulation voltage (Ui)		(V)	690	690	690	690	690	690	690		
Rated Capacity	IEC 60947-4-1 EN 60947-4-1 DIN VDE 0660  AC 3 (kW/HP/A)	AC-6b 3 ø (kVar/A)	200~240V	6.7/ 18	8.5/ 22	10/ 26	15/ 39	20/ 48	25/ 66	35/ 92	60/118
			400~440V	12.5/ 16	16.7/ 22	20/ 26	25/ 33	33.3/ 44	45/ 59	60/ 86	70/101
			660~690V	18/ 15	24/ 20	30/ 25	36/ 30	48/ 40	58/ 49	75/ 63	90/78
	Continuous Current (Ith) AC1 (A)		20	30	40	50	80	90	100	135	
Auxiliary Contact		2NO or 1NO 1NC	2NO 1NC	2NO 1NC	3NO 2NC	3NO 2NC	3NO 2NC	3NO 2NC	3NO 2NC		
Auxiliary Contact	IEC 60947-5-1 EN 60947-5-1	AC12 (A)	110V	6	6	6	6	6	6	6	
			220V	5	5	5	5	5	5	5	
			440V	3	3	3	3	3	3	3	
			550V	3	3	3	3	3	3	3	
	Continuous Current (Ith) (A)		16	16	16	16	16	16	16	16	
Mechanical Life / Electrical Life (AC-6b) ≤440V (10 thousand)		100 / 30	100 / 30	100 / 30	100 / 30	100 / 30	100 / 30	100 / 30	600/20		
Operation Frequency		(time/ hour)	240	240	240	240	240	100	100		
Magnetic Contactor	Weight		(kg)	0.42	0.47	0.47	0.63	1.14	1.14	1.59	2.4
	Installation Dimensions (WxHxD)		(mm)	44x108x134	54x112x134	54x112x134	74x185x144	89x185x158	89x185x158	101x195x168	120 x 180 x 169
	Dimensions		(mm)								

**Capacitor Unit**



Capacitor Unit	Magnetic Contactor	Maximum operating power(kvar)			Max. peak current(A)
		220~240V	400~440V	660~690V	
AP-40 A	S-P11	6.7	12.5	18	560
	S-P16	8.5	16.7	24	560
	S-P21	10	20	30	1250
AP-40 B	S-P40T	15	25	36	1900
	S-P50T	20	33.3	48	2160
	S-P60T	25	45	58	3040
	S-P80T	35	60	75	3040

Motor Starter

Index

MCCB  
ELCB

ATS

ACB

MCB

SPD

MS

MMS

BO

49

Thermal Overload Relay

Motor Starter



Type		12		18		20			
Standard	Contactor Assembled Type	TH-P12ES		TH-P18E		TH-P20ES		TH-P20ES TA	
	#3 Separate Installed Type	Install UATP12		TH-P18ER		-		-	
Differential type	Contactor Assembled Type	TH-P12ES PP		TH-P18PP		TH-P20ES PP		TH-P20ES TAPP	
	#3 Separate Installed Type	Install UATP12		TH-P18PPR		-		-	
Reset Mode		Manual / Automatic		Manual / Automatic		Manual / Automatic			
Magnetic Contactor		S-P09T, S-P11, S-P12T, S-P15.		S-P16, S-P21		S-P16, S-P21, S-P25, S-P30T, S-P32T, S-P35T, S-P38T, S-P40T.		S-P25, S-P30T, S-P32T, S-P35T, S-P38T, S-P40T.	
Index MCCB ELCB ATS ACB MCB SPD MS MMS	TOR Adjustment Range (A)	Rating (A)	Range (A)	Rating	Range	Rating (A)	Range (A)	Rating (A)	Range (A)
		0.25	0.19~0.31	0.25	0.19 - 0.31	0.25	0.19~0.31	28	22~34
		0.4	0.3~0.5	0.4	0.3 - 0.5	0.4	0.3~0.5	33	28~38
		0.6	0.45~0.75	0.6	0.45 - 0.75	0.6	0.45~0.75	40	32~48
		0.9	0.7~1.1	0.9	0.7-1.1	0.9	0.7~1.1		
		1.2	0.9~1.5	1.2	0.9-1.5	1.2	0.9~1.5		
		1.7	1.3~2.1	1.7	1.3-2.1	1.7	1.3~2.1		
		2.1	1.6~2.6	2.1	1.6-2.6	2.1	1.6~2.6		
		3.3	2.5~4.1	3.3	2.5-4.1	3.3	2.5~4.1		
		4.4	3.4~5.4	4.4	3.4-5.4	4.4	3.4~5.4		
		6.5	5~8	6.5	5 - 8	6.5	5~8		
		9	7~11	9	7-11	9	7~11		
		11	9~13	11	9-13	11	9~13		
		*15	12~18	15	12-18	15	12~18		
				21	17-24	21	17~24		
Auxiliary Contact		1NO 1NC		1NO 1NC		1NO 1NC			
Weight		0.11/0.12		0.15		0.18/0.19		0.20/0.21	
Appearance Dimensions (WxHxD)		TH-P12ES PP: 45.5x55.5x78 TH-P12ES PP: 47x71x86.2		53.5x55.5x78.5		TH-P12ES PP: 64.5x46.1x80		TH-P12ES TAPP: 64.5x56.2x80	

Installation Dimensions (mm)

TH-P12ES PP:  
TH-P12(PP)R:

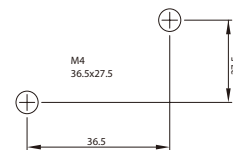
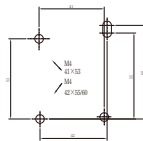
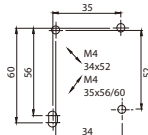

- Note.
1. The purpose of using TOR is protecting load tripping. For protecting circuit, please choose circuit breaker.
  2. When adjusting the rated current; please refer to the TOR range table above. Do not exceed its range.
  3. (E): 3 Elements
  4. \*: The rating current of TH-P12 can only use up to "11A" when combined with S-P11.





60		120		220T		400T		600CT					
TH-P60ES	TH-P60ES TA	TH-P120E	TH-P120ETA	TH-P220TE	TH-P400TE	TH-P600CTE							
TH-P60PP	TH-P60ES TAPP	TH-P120PP	TH-P120TAPP	TH-P220TTP	TH-P400TTP	TH-P600CTPP							
Manual / Automatic		Manual / Automatic		Manual / Automatic		Manual / Automatic		Manual / Automatic					
S-P50T, S-P60T, S-P80T.		S-P60T, S-P80T.		S-P100T, S-P125T, S-P150T.		S-P200T, S-P220T.		S-P300T, S-P400T.		S-P630T, S-P800T.			
Rated (A)	Adjustable Range (A)	Rated (A)	Adjustable Range (A)	Rated (A)	Adjustable Range (A)	Rated (A)	Adjustable Range (A)	Rated (A)	Adjustable Range (A)	Rated (A)	Adjustable Range (A)		
11	9~13	67	54~80	40	32~48	105	80~130	80	60~100	105	80~130	260	200~320
15	12~18	80	60~100	54	43~65	130	100~160	105	80~130	130	100~160	350	260~440
21	17~24			67	54~80	160	120~200	130	100~160	160	120~200	500	400~600
28	22~34			80	60~100			160	120~200	200	150~250		
33	28~38							200	150~250	260	200~320		
40	32~48									350	260~440		
54	43~65												
1NO 1NC		1NO 1NC		1NO 1NC		1NO 1NC		1NO 1NC		1NO 1NC		1NO 1NC	
0.28/ 0.30		0.34/ 0.36		0.55		0.76		2.25		2.65		3.93/ 3.95	
TH-P60ES PP: 98x50.5x78		TH-P60ES TAPP: 64.5x65.5x80		TH-P120(PP): 133x54x105		TH-P120TA(PP): 133x85.5x105		140x151.5x158.7		164x165x163.7		TOR: 64.5x46.1x80 TOR W/CT: 106x46.8x104.5	

Index

MCCB  
ELCB

ATS

ACB

MCB

SPD

MS

MMS

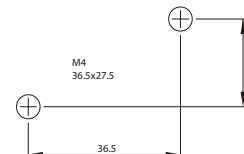
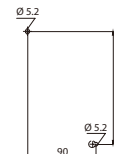
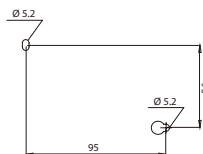
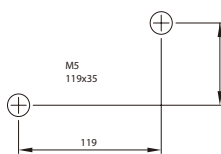
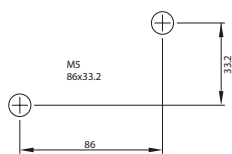

## Magnetic Control Relays



Type		SR-P40	SR-P50	SR-P80
<b>Auxiliary Contact</b>		4NO 3NO 1NC 2NO 2NC	5NO 4NO 1NC 3NO 2NC 2NO 3NC	8NO 7NO 1NC 6NO 2NC 5NO 3NC 4NO 4NC
<b>Rated Capacity</b> IEC 60947-4-1 AC15 (A)	<b>220V</b>	1.6	1.6	1.6
	<b>380V</b>	0.95	0.95	0.95
<b>Rated insulation voltage</b>	<b>(Ui) (V)</b>	660	660	660
<b>Operation current</b>	<b>(Ith) (A)</b>	16	16	16
<b>Contact Class</b>	<b>(UL)</b>	A600, Q300	A600, Q300	A600, Q300
<b>Electrical Life</b>	<b>(10 thousand)</b>	50 and up	50 and up	50 and up
<b>Mechanical Life</b>	<b>(10 thousand)</b>	500	500	500
<b>On/ Off Frequency</b>	<b>(time per / hour)</b>	500	500	500

## Definite Purpose Magnetic Contactor | SF Series

Type		20	25	30	35	40
		C1	C2	C3		
Type	1 Pole	SF20C1	SF25C1	SF30C1	SF35C1	SF40C1
	2 Pole	SF20C2	SF25C2	SF30C2	SF35C2	SF40C2
	1Pole w/shunt	SF20C3	SF25C3	SF30C3	SF35C3	SF40C3
Start Current(A) (Per Pole)	AC 240V / AC 277V	120	150	180	180	180
	AC 480V	100	125	150	150	150
	AC 600V	80	100	120	120	120
Start Current(A) (Single Phase) (2 Pole)	AC 240V / AC 277V	120	150	180	210	240
	AC 480V	100	125	150	175	200
	AC 600V	80	100	120	140	160
Rated Current w/resistance load (A)		30	35	40	50	50
Full Rated Current (A)		20	25	30	35	40
Mechanical / Electrical life ( 10 thousand )		50/25	50/25	50/25	50/25	50/25
Operation frequency ( time / hour )		360	360	360	360	360
Coil Control Voltage 50/60 Hz		24 / 110-120 / 200 / 220 / 208-240 / 277				



### Star-delta Starter

Model		21	35	50	60	80	100	125	150	220
Type	Without enclosure (no CT)	SDO-P21	SDO-P35	SDO-P50	SDO-P60	SDO-P80	SDO-P100	SDO-P125	SDO-P150	SDO-P220
	Without enclosure (with CT)	SDO-P21T	SDO-P35T	SDO-P50T	SDO-P60T	SDO-P80T	SDO-P100T	SDO-P125T	SDO-P150T	SDO-P220T
	With enclosure (no Ammeter)	SDE-P21	SDE-P35	SDE-P50	SDE-P60	SDE-P80	SDE-P100	SDE-P125	SDE-P150	SDE-P220
	With enclosure (With Ammeter)	SDA-P21	SDA-P35	SDA-P50	SDA-P60	SDA-P80	SDA-P100	SDA-P125	SDA-P150	SDA-P220
Rated Capacity (kW/HP)	200V~220V	11/ 15	19/ 25	22/ 30	30/ 40	37/ 50	45/ 60	55/ 75	75/ 100	110/ 150
	380V~440V	19/ 25	30/ 40	45/ 60	55/ 75	75/ 100	90/ 125	110/ 150	132/ 180	200/ 260
AC Magnetic Contactor	MCM	S-P21	S-P35T	S-P50T	S-P60T	S-P80T	S-P100T	S-P125T	S-P150T	S-P220T
	MCD	S-P21	S-P35T	S-P50T	S-P60T	S-P80T	S-P100T	S-P125T	S-P150T	S-P220T
	MCS	S-P11	S-P16	S-P21	S-P21	S-P35T	S-P35T	S-P50T	S-P50T	S-P60T
Thermal Overload Relay		TH-P20	TH-P60	TH-P60	TH-P120	TH-P120	TH-P120	TH-P220T	TH-P220T	TH-P400T
		TH-P20TA	TH-P60TA	TH-P60TA	TH-P120TA	TH-P120TA	TH-P120TA	TH-P220T	TH-P400T	TH-P400T
Conducting wire size of motor (mm <sup>2</sup> )	Line side	2.5~16	2.5~25	2.5~35	2.5~50	10~70	10~95	35~150	35~150	35~240
	Load side	2.5~10	2.5~16	2.5~25	2.5~35	4~50	4~70	10~95	10~90	16~150
	Control side	1~2.5	1~2.5	1~2.5	1~2.5	1~2.5	1~2.5	1~2.5	1~2.5	1~2.5

### Push Button | PB Series

Type	PB2	PB3
Contact schema		

External dimensions (mm)

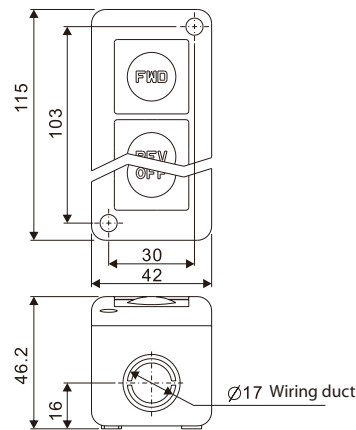
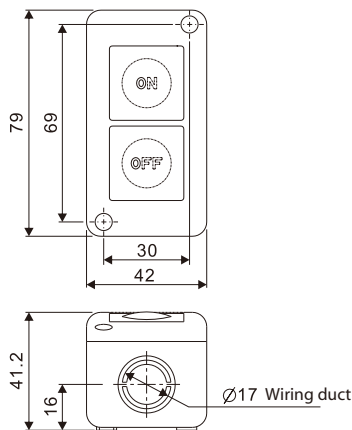

WET.

72.5g

110g

### Separate Mounting Unit



Type	UATP12
TOR	TH-P12

BO

53



## Auxiliary Contact Block

### ◆ AP Series

Installation		2P FRONT MOUNTED TYPE						4P FRONT MOUNTED TYPE						
<b>Model</b>		AP-20	AP-11	AP-02	AP-20N	AP-11N	AP-02N	AP-40	AP-31	AP-22	AP-40N	AP-31N	AP-22N	AP-13N
<b>Contact</b>		2NO	1NO 1NC	2NC	2NO	1NO 1NC	2NC	4NO	3NO 1NC	2NO 2NC	4NO	3NO 1NC	2NO 2NC	1NO 3NC
<b>Applicable contactor</b>		SR-P40, SR-P50 S-P09T~ S-P80T SD-P11~ SD-P21			S-P100E S-P100T S-P630T~ S-P1260T			SR-P40, SR-P50 S-P09T~ S-P80T SD-P11~ SD-P21			S-P100E S-P100T S-P630T~ S-P1260T			
<b>Rated Capacity AC 15 (A)</b>	<b>220V</b>	1.6			3			1.6			3			
	<b>380V</b>	0.95			1.9			0.95			1.9			
<b>Operation current</b>	<b>(Ith) (A)</b>	16			10			16			10			

## Auxiliary Contact Block

### ◆ AP Series



Installation		SIDE MOUNTED TYPE	
<b>Model</b>		APS-11	APL-11
<b>Contact</b>		1NO 1NC	1NO 1NC
<b>Applicable contactor</b>		SR-P40, SR-P50 S-P09T~ S-P60T SD-P11~ SD-P21	S-P125, S-P150T S-P200T, S-P220T S-P300T, S-P400T
<b>Rated Capacity AC 15 (A)</b>	<b>220V</b>	1.6	
	<b>380V</b>	0.95	
<b>Operation current</b>	<b>(Ith) (A)</b>	16	

## Auxiliary Contact Block

### ◆ MAP Series

Installation		2P FRONT MOUNTED TYPE			4P FRONT MOUNTED TYPE		
<b>Model</b>		MAP-20	MAP-11	MAP-02	MAP-40	MAP-31	MAP-22
<b>Contact</b>		2NO	1NO 1NC	2NC	4NO	3NO 1NC	2NO 2NC
<b>Applicable contactor</b>		S-P06, S-P09.					
<b>Rated Capacity AC 15 (A)</b>	<b>220V</b>	3.3					
	<b>380V</b>	1.9					
<b>Operation current</b>	<b>(Ith) (A)</b>	10					



## Timer

Model		PTR-30	PRT-30F	PTR-180	PRT-180F
<b>Delay type</b>		On Delay	Off Delay	On Delay	Off Delay
<b>Ajustable time (Sec)</b>		0~30			0~180
<b>Rated Capacity AC 15 (A)</b>	<b>220V</b>	1.6			
	<b>380V</b>	0.95			
<b>Operation current (Ith) (A)</b>		16			
<b>Applicable contactor</b>		SR-P40, SR-P50, S-P09T~60T, SD-P11~21			



## Surge unit

Model	BMSACW220V	BMSACW380V
Applicable contactor	SR-P40, SR-P50, S-P9T~ S-P60T.	

## Mechanical Interlock

Model	MPU-11	MPU-21	MPU-50
Applicable contactor	S-P11/S-P15/S-P35T~60T	S-P12/S-P16~30T	S-P80T

## Coil Characteristics

Model	S-P06 S-P09	S-P9T S-P12T	S-P11 S-P15	S-P16 S-P21 S-P25 S-P32T	S-P30T S-P35T S-P38T S-P40T	S-P50T S-P60T S-P80T	S-P100T	S-P125T S-P150T	S-P200T S-P220T	S-P300T S-P400T	S-P630T S-P800T S-P1260T			
Coil type	AC	AC	AC	AC	AC	AC	AC	AC	AC/DC	AC	AC/DC	AC/DC	AC/DC	
Coil Capacity (VA)	Impulse	35	76	76	76	72	250	319	370	350	440	350	420	500~1000
	Operation	8	9	9	9	12	28	36	42	20	50	20	27	15~35
Power Consumption (W)	2.5	2.7	2.7	2.7	3	7	11	10	1.3~8	12	1.3~8	3	4~8	
Operation Volt. (Us)	On	55~70%	55~75%	55~75%	59~75%	60~75%	63~75%	65~75%	75~80%	Above 75%	75~80%	Above 75%	65~80%	Above77%
	Off	25~50%	35~50%	34~48%	36~52%	40~57%	40~57%	40~55%	40~55%	20~62%	40~60%	20~62%	20~50%	20~60%
Close Time (ms)	Aux. OFF	8~15	6~14	6~14	6~14	6~13	6~13	18~28	9~20	15~45	10~19	20~45	22~37	-
	Aux. ON	10~18	12~20	12~20	12~25	12~20	12~20	22~32	15~24	18~45	17~25	20~45	25~40	-
	Contact ON	10~18	12~20	12~20	12~25	12~20	12~20	22~32	10~20	18~50	12~27	24~50	30~45	50~70
Open Time (ms)	Aux. OFF	9~20	13~22	13~22	13~24	10~17	10~17	50~100	9~18	30~70	10~20	40~70	40~60	-
	Aux. ON	12~23	6~17	6~17	6~17	5~12	5~12	48~98	7~15	30~70	7~18	25~70	31~51	-
	Contact ON	9~20	6~17	6~17	6~17	5~12	5~12	46~96	7~15	40~70	7~20	40~70	30~50	40~60

## Coil Specifications Table

◆ S-P9T~S-P25, S-P30T~P220T, SR-P40~P80, SC-P12~P60						
Description	AC12V	AC24V	AC48V	AC110V	AC120V	AC220V
Coil rated specifications marking	12V 50Hz 12V 60Hz	24V 50Hz 24V 60Hz	48~50V 50Hz 48~50V 60Hz	100V 50Hz 100~110V 60Hz	110~120V 50Hz 115~120V 60Hz	200~220V 50Hz 220V 60Hz
Description	AC230V	AC240V	AC380V	AC440V	AC480V	AC550V
Coil rated specifications marking	230V 50Hz 230V 60Hz	220~240V 50Hz 240~260V 60Hz	346~380V 50Hz 380V 60Hz	400V 50Hz 400~440V 60Hz	415~440V 50Hz 460~480V 60Hz	500V 50Hz 500~550V 60Hz

"Note: Control voltage of SR-P40 can be customized DC 12/24/30/48/72/110/125/220V."

◆ S-P300T~P400T					
Description	AC48V	AC100V	AC220V	AC380V	AC550V
Coil rated specifications marking	AC 48~50V 50/60Hz DC 48V	AC 100~127V 50/60Hz DC 100~127V	AC 220~250V 50/60Hz DC 200~250V	AC 265~450V 50/60Hz	AC 440~575V 50/60Hz

◆ S-P630T~S-P1260T			
Description	AC110V	AC220V	AC380V
Coil rated specifications marking	AC 100~127V 50/60Hz DC 100~127V	AC 200~250V 50/60Hz DC 200~250V	AC 380~440V 50/60Hz

Motor Starter

Index

MCCB  
ELCB

ATS

ACB

MCB

SPD

MS

MMS

BO

55



**Selection Table** ◆ **Direct On-Line Starter**

Motor rated capacity kW (HP)		3 φ 200V~220V								
		Heating element rating (A)		Selection of the contactor						
0.016	(1/47)	0.13A	0.1~0.16A	S-P06	S-P09					
0.025	(1/30)	0.2A	0.16~0.24A							
0.04	(1/19)	0.32A	0.24~0.4A							
0.09	(1/8)	0.5A	0.4~0.6A							
0.12	(1/6)	0.8A	0.6~1.0A							
0.25	(1/3)	1.3A	1.0~1.6A							
0.37	(1/2)	2.0A	1.6~2.4A							
0.75	(1)	3.2A	2.4~4.0A							
1.1	(1 1/2)	5A	4.0~6.0A							
1.5	(2)	7.5A	6.0~9.0A	S-P09T, S-P11, S-P12T	S-P15, S-P16	S-P21	S-P25	S-P30T, S-P32T	S-P35T, S-P38T	S-P40T
0.03	(1/25)	0.25A	0.19~0.31A							
0.05	(1/15)	0.4A	0.3~0.5A							
0.1	(1/8)	0.6A	0.45~0.75A							
0.15	(1/5)	0.9A	0.7~1.1A							
0.2	(1/4)	1.2A	0.9~1.5A							
0.3	(2/5)	1.7A	1.3~2.1A							
0.4	(1/2)	2.1A	1.6~2.6A							
0.75	(1)	3.3A	2.5~4.1A							
1.1	(1 1/2)	4.4A	3.4~5.4A							
1.5	(2)	6.5A	5~8A							
2.2	(3)	9A	7~11A							
3	(4)	11A	9~13A							
3.7	(5)	15A	12~18A							
5.5	(7 1/2)	21A	17~24A							
6.5	(8 1/2)	28A	22~34A							
7.5	(10)	33A	28~38A							
9	(12 1/2)	40A	32~48A							
11	(15)	54A	43~65A							
15	(20)	67A	54~80A							
19	(25)	80A	60~100A							
22	(30)	105A	80~130A	S-P100T	S-P125T	S-P150T				
25	(35)	130A	100~160A							
30	(40)	160A	120~200A							
37	(50)	200A	150~250A	S-P200T	S-P220T	S-P300T	S-P400T			
45	(60)	260A	200~320A							
55	(75)	350A	260~440A	M-600C						
65	(85)	500A	400~600A							
75	(100)									
90	(125)									
110	(150)									
132	(180)									
160	(220)									

Motor Starter

Index

MCCB  
ELCB

ATS

ACB

MCB

SPD

MS

MMS

**Selection Table** ◆ **Direct On-Line Starter**

Motor rated capacity kW (HP)		3 φ 380V~440V		Heating element rating (A)		Selection of the contactor	
		Heating element rating (A)	Selection of the contactor				
0.025	(1/30)	0.13A	0.1~0.16A	S-P06	S-P09		
0.04	(1/19)	0.2A	0.16~0.24A				
0.09	(1/8)	0.32A	0.24~0.4A				
0.18	(1/4)	0.5A	0.4~0.6A				
0.25	(1/3)	0.8A	0.6~1.0A				
0.37	(1/2)	1.3A	1.0~1.6A				
0.55	(3/4)	2.0A	1.6~2.4A				
0.75	(1)						
1.1	(1 1/2)	3.2A	2.4~4.0A				
1.5	(2)						
2.2	(3)	5A	4.0~6.0A				
3	(4)	7.5A	6.0~9.0A				
0.05	(1/15)	0.25A	0.19~0.31A	S-P09T, S-P11, S-P12T	S-P15, S-P16		
0.1	(1/8)	0.4A	0.3~0.5A				
0.2	(1/4)	0.6A	0.45~0.75A				
0.3	(2/5)	0.9A	0.7~1.1A				
0.4	(1/2)	1.2A	0.9~1.5A				
0.75	(1)	1.7A	1.3~2.1A				
1.1	(1 1/2)	2.1A	1.6~2.6A				
1.5	(2)	3.3A	2.5~4.1A				
2.2	(3)	4.4A	3.4~5.4A				
3	(4)	6.5A	5~8A				
3.7	(5)						
4	(5 1/2)	9A	7~11A				
4.5	(6)						
5.5	(7 1/2)	11A	9~13A				
7.5	(10)	15A	12~18A				
11	(15)	21A	17~24A				
12	(16)						
15	(20)	28A	22~34A				
19	(25)	33A	28~38A				
22	(30)						
25	(35)	40A	32~48A				
30	(40)	54A	43~65A				
37	(50)	67A	54~80A				
45	(60)						
50	(70)	80A	60~100A				
60	(80)	105A	80~130A				
75	(100)	130A	100~160A				
90	(125)	160A	120~200A				
110	(150)	200A	150~250A				
132	(180)						
150	(200)	260A	200~320A				
160	(220)						
220	(330)	350A	260~440A				
250	(350)						
315	(420)	500A	400~600A				

**Motor Starter**

- Index
- MCCB ELCB
- ATS
- ACB
- MCB
- SPD
- MS
- MMS

### Selection Table ◆ Direct On-Line Starter

Motor rated capacity kW (HP)		3 φ 500V~550V										
		Heating element rating (A)		Selection of the contactor								
0.06	(1/12)	0.13A	0.1~0.16A	S-P06	S-P09							
0.09	(1/8)	0.2A	0.16~0.24A									
0.12	(1/6)	0.32A	0.24~0.4A									
0.18	(1/4)	0.5A	0.4~0.6A									
0.37	(1/2)	0.8A	0.6~1.0A									
0.55	(3/4)	1.3A	1.0~1.6A									
0.75	(1)	2.0A	1.6~2.4A									
1.1	(1 1/2)											
1.5	(2)	3.2A	2.4~4.0A									
2.2	(3)											
3	(4)	5A	4.0~6.0A									
4	(5 1/2)	7.5A	6.0~9.0A									
0.12	(1/6)	0.25A	0.19~0.31A	S-P9T, S-P11, S-P12T	S-P15, S-P16	S-P21	S-P25	S-P30T, S-P32T	S-P35T, S-P38T	S-P40T		
0.18	(1/4)	0.4A	0.3~0.5A									
0.25	(1/3)	0.6A	0.45~0.75A									
0.37	(1/2)	0.9A	0.7~1.1A									
0.55	(3/4)	1.2A	0.9~1.5A									
0.75	(1)	1.7A	1.3~2.1A									
1.1	(1 1/2)	2.1A	1.6~2.6A									
1.5	(2)	3.3A	2.5~4.1A									
2.2	(3)	4.4A	3.4~5.4A									
4	(5 1/2)	6.5A	5~8A									
4.5	(6)	9A	7~11A									
5.5	(7 1/2)	11A	9~13A									
7.5	(10)	15A	12~18A									
11	(15)	21A	17~24A									
12	(16)											
15	(20)	28A	22~34A									
19	(25)	33A	28~38A									
22	(30)	40A	32~48A									
30	(40)	54A	43~65A									
37	(50)											
45	(60)	67A	54~80A									
50	(70)											
60	(80)	80A	60~100A									
75	(100)	105A	80~130A									
90	(125)	130A	100~160A									
110	(150)	160A	120~200A									
132	(180)											
150	(200)	200A	150~250A									
160	(220)	260A	200~320A									
220	(330)	350A	260~440A									
315	(420)	500A	400~600A									

**Motor Starter**
**Index**
**MCCB  
ELCB**
**ATS**
**ACB**
**MCB**
**SPD**
**MS**
**MMS**
**BO**
**58**

**Selection Table** ◆ **λ-Δ Starter**

Heater selection table (A)	Motor output kW (HP)				TH selection of λ-Δ Starter																	
	A		B		21		35		50		60		80		100		125		150		220	
	200~220V		380~440V		A	B	A	B	A	B	A	B	A	B	A	B	A	B	A	B	A	B
6.5	1.5	(2)	3	(4)	TH-P20	TH-P20																
9	1.9	(2 1/2)	3.7	(5)																		
9	2.2	(3)	4.5	(6)																		
11	3	(4)	5.5	(7 1/2)																		
15	3.7	(5)	7.5	(10)																		
15	4.5	(6)	10	(13)																		
21	5.5	(7 1/2)	11	(15)																		
28	6.5	(8)	14	(19)	TH-P20TA	TH-P20TA	TH-P60	TH-P60	TH-P60	TH-P60												
28	7.5	(10)	15	(20)																		
33	9	(12 1/2)	19	(25)																		
40	11	(15)	22	(30)	TH-P120	TH-P120	TH-P120	TH-P120	TH-P120	TH-P120	TH-P120	TH-P120	TH-P120	TH-P120	TH-P120	TH-P120	TH-P120	TH-P120	TH-P120	TH-P120	TH-P120	TH-P120
40	14	(19)	26	(35)																		
54	15	(20)	30	(40)																		
67	19	(25)	37	(50)	TH-P60TA	TH-P60TA	TH-P60TA	TH-P60TA	TH-P60TA	TH-P60TA	TH-P60TA	TH-P60TA	TH-P60TA	TH-P60TA	TH-P60TA	TH-P60TA	TH-P60TA	TH-P60TA	TH-P60TA	TH-P60TA	TH-P60TA	TH-P60TA
80	22	(30)	45	(60)																		
80	25	(34)	50	(67)																		
105	30	(40)	55	(75)	TH-P120TA	TH-P120TA	TH-P120TA	TH-P120TA	TH-P120TA	TH-P120TA	TH-P120TA	TH-P120TA	TH-P120TA	TH-P120TA	TH-P120TA	TH-P120TA	TH-P120TA	TH-P120TA	TH-P120TA	TH-P120TA	TH-P120TA	TH-P120TA
130	37	(50)	75	(100)																		
160	45	(60)	90	(125)																		
200	55	(75)	110	(150)	TH-P220T	TH-P220T	TH-P220T	TH-P220T	TH-P220T	TH-P220T	TH-P220T	TH-P220T	TH-P220T	TH-P220T	TH-P220T	TH-P220T	TH-P220T	TH-P220T	TH-P220T	TH-P220T	TH-P220T	TH-P220T
200	65	(85)	132	(200)																		
260	75	(100)	150	(200)																		
350	110	(150)	200	(260)	TH-P400T	TH-P400T	TH-P400T	TH-P400T	TH-P400T	TH-P400T	TH-P400T	TH-P400T	TH-P400T	TH-P400T	TH-P400T	TH-P400T	TH-P400T	TH-P400T	TH-P400T	TH-P400T	TH-P400T	TH-P400T

Motor Starter

Index

MCCB  
ELCB

ATS

ACB

MCB

SPD

MS

MMS

## Modular Contactor



Model	Modular Contactors	Standard	SMC16-S		SMC25-S		SMC40-S		SMC63-S	
		Manual	SMC16-M		SMC25-M		SMC40-M		SMC63-M	
		Pole	2P	4P	2P	4P	2P	4P	2P	4P
Rated insulation voltage (Ui) IEC		(V)	500	500	500	500	500	500	500	500
Rated operational voltage (Ue) IEC / UL		(V)	230	400	250	400	250	400	250	400
Rated impulse withstand voltage (Uimp) IEC		(kV)	4	4	4	4	4	4	4	4
Rated operational current		AC-7a (A)	16	16	25	25	40	40	63	63
		AC-7b (A)	6	6	8.5	8.5	15	15	20	20
Continuous Current (Ith)		(A)	25	25	25	25	63	63	63	63
Mechanical Life (Thousand)		(Thousand)	100							
Electrical Life AC-7a (Thousand)		(Thousand)	10							
IP Level		—	IP20							

Index

MCCB  
ELCB

ATS

ACB

MCB

SPD

MS

MMS

## Accessory

- Side mount auxiliary contacts



Model	Contacts	Voltage
smAX11	1NO1NC	500V

- 9mm spacing block



Model	Usage
smSB	When modular contactor is installed in distribution box, attach spacing block on both side of the contactor for heat radiation

MANUAL MOTOR STARTER

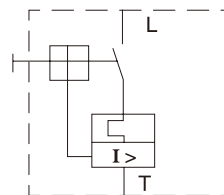
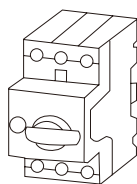

Power factor AC-3		Rated current	Overload adjustable range	Tripping current (A)	Type	
220V (kW)	400V (kW)	$I_n$ (A)	$I_e$ (A)	$I_d \pm 20\%$	Button	Rotary
—	—	0.16	0.1-0.16	1.92	MR-32S-0.16	MR-32R-0.16
—	—	0.25	0.16-0.25	3	MR-32S-0.25	MR-32R-0.25
—	—	0.4	0.25-0.4	4.8	MR-32S-0.4	MR-32R-0.4
—	—	0.63	0.4-0.63	7.56	MR-32S-0.63	MR-32R-0.63
—	—	1	0.63-1	12	MR-32S-1	MR-32R-1
—	0.37	1.6	1-1.6	19.2	MR-32S-1.6	MR-32R-1.6
0.37	0.75	2.5	1.6-2.5	30	MR-32S-2.5	MR-32R-2.5
0.55	1.5	4	2.5-4	48	MR-32S-4	MR-32R-4
1.1	2.2	6.3	4-6.3	75.6	MR-32S-6.3	MR-32R-6.3
2.2	4	10	6-10	120	MR-32S-10	MR-32R-10
2.2	5.5	14	9-14	168	MR-32S-14	MR-32R-14
3.7	7.5	18	13-18	216	MR-32S-18	MR-32R-18
5.5	11	23	17-23	276	MR-32S-23	MR-32R-23
5.5	11	25	20-25	300	MR-32S-25	MR-32R-25
7.5	15	32	24-32	384	MR-32S-32	MR-32R-32
3	5.5	13	9-13	182	—	MR-65R-13
4	7.5	18	12-18	252	—	MR-65R-18
5.5	11	25	17-25	350	—	MR-65R-25
7.5	15	32	23-32	448	—	MR-65R-32
7.5	18.5	40	30-40	560	—	MR-65R-40
11	22	50	37-50	700	—	MR-65R-50
15	30	65	48-65	910	—	MR-65R-65

Magnetic Switch

Index

MCCB  
ELCB

ATS

ACB

MCB

SPD

MS

MMS

Side AX (MR-AN)

Front AX (MR-AE)

SHT (MR-AS)

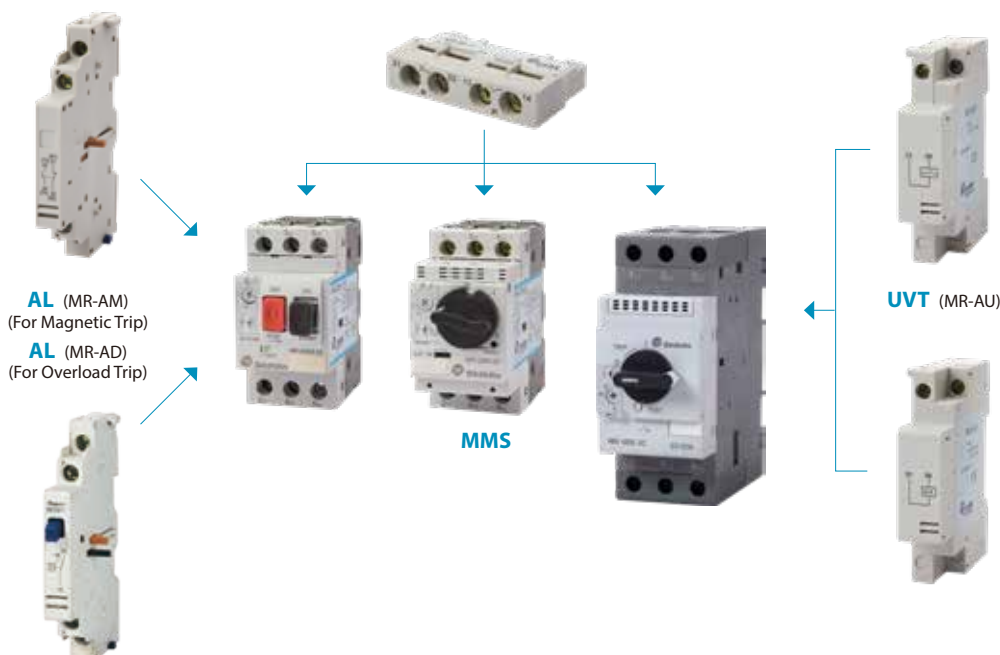



CIRCUIT BREAKER ( MCCB / ELCB / EMCCB / MCB )

## Breaker & Switchgear System



AIR CIRCUIT BREAKER

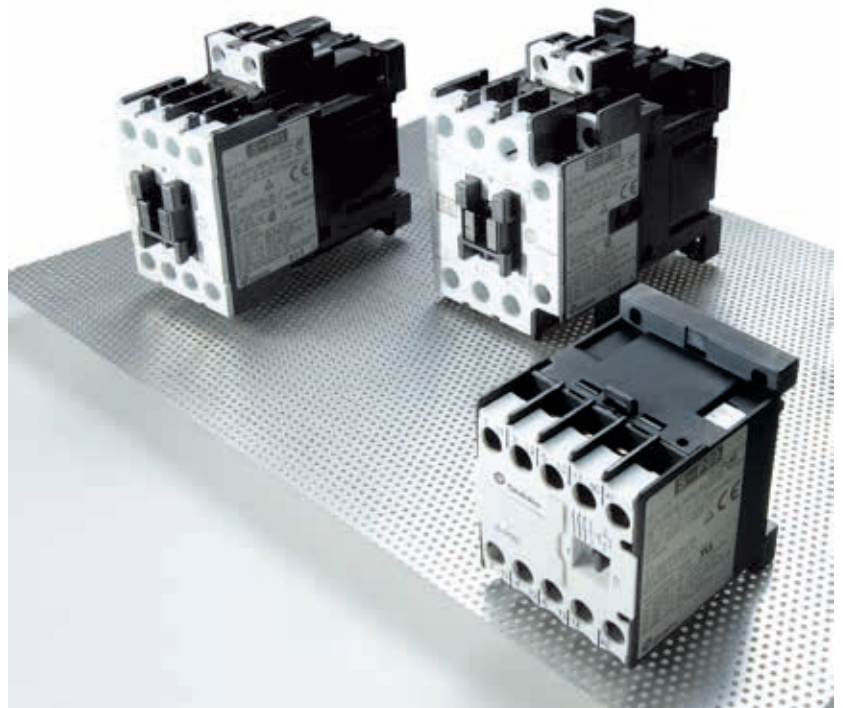

MAGNETIC CONTACTOR / SWITCH ( CONTACTOR / MS / MMS )



AUTOMATIC TRANSFER SWITCHES



SURGE PROTECTIVE DEVICE



SMART METER



INVERTER



LOW VOLTAGE POWER CAPACITORS

# SHIHLIN ELECTRIC & ENGINEERING

MAGNETIC CONTACTOR / SWITCH (CONTACTOR/ MS/ MMS), CIRCUIT BREAKER (MCCB/ ELCB/ EMCCB/ MCB), AIR CIRCUIT BREAKER, AUTOMATIC TRANSFER SWITCHES, SURGE PROTECTIVE DEVICE, SMART METER, LOW VOLTAGE POWER CAPACITORS, INVERTER



#### **Breaker & switchgears overseas sales dept.**

3F, No.9, Sec. 1, Chang-an E. Rd., Zhongshan Dist., Taipei City 10441, Taiwan

T. +886-2-2541-9822 F. +886-2-2581-2665

e-mail. [b.export@seec.com.tw](mailto:b.export@seec.com.tw)

<http://circuit-breaker.seec.com.tw>

#### **Headquarters**

16F, No.88, Sec. 6, Zhongshan N. Rd., Shilin Dist., Taipei City 11155, Taiwan

T. +886-2-2834-2662 F. +886-2-2836-6187

<http://www.seec.com.tw>

#### **KIM QUANG ELECTRIC DISTRIBUTOR**

Hotline: 0931 455 668

Sales: 0909 635 266  
0938 118 428

Distributor

B240110E.ALL-BO.PRINT