



KIM QUANG ELECTRIC DISTRIBUTOR

www.kimquang.vn
www.kimquang.com.vn

Hotline: 0931 455 668

2013

ACB/ MCCB/ ELCB/ ATS MCB/ SPD/ MS/ MMS



Index

A. MCCB/ EMCCB/ ELCB / MCB	P02
B. ATS (MCCB TYPE 、 MS TYPE)	P22
C. ACB	P23
D. MCB/ RCBO	P24
E. SPD / TVSS	P26
F. MS	P27
G. MMS	P44

Index

MCCB
ELCB

ATS

ACB





MCB

SPD

MS





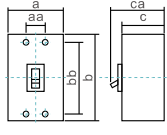

MMS

MCCB (Molded Case Circuit Breaker)

Frame size (AF) (Inm)		30		50		60								
Type		BM30-CN		BM30-SN		BM50-CN		BM60-SN			BM60-HN			
Photograph														
Rated current In (A) at ambient temp. 40°C		3, 5, 10, 15, 20, 30.		3, 5, 10, 15, 20, 30.		10, 15, 20, 30, 40, 50.		10, 15, 20, 25, 30, 40, 50, 60.			10, 15, 20, 25, 30, 40, 50, 60.			
Number of poles (P)		2	3	2	3	2	3	2	3	4	2	3	4	
Rated insulation voltage Ui (V)		AC 690		690		690		690			690			
		DC 250		250		—		250			250			
Dimensions		a	45	67.5	50	75	50	75	50	75	100	50	75	100
		b	96		130		130		130			130		
		c	52		68		68		68			68		
		ca	67		90		90		90			90		
		bb	84		111		111		111			111		
		aa	23.5		25		25		25			25		
Weight (kg)		0.3	0.4	0.45	0.65	0.45	0.65	0.45	0.65	0.85	0.45	0.65	0.85	
Rated breaking capacity (kA)	IEC 60947-2 EN 60947-2 AC	500V	—		1.5		1.5		5			5		
		440V	—		2.5		2.5		7.5			10		
		380V	1.5		2.5		2.5		7.5			15		
		220V(240V)	2.5		5		5		10			25		
	DC	250V	—		—		—		—			—		
		125V	—		—		—		—			—		
Connection		Clamp terminal		Clamp terminal		Clamp terminal		Clamp terminal			Clamp terminal			
Optional accessories	Alarm switch (AL)	—		○		○		○			○			
	Auxiliary switch (AX)	—		○		○		○			○			
	Shunt trip (SHT)	—		○		○		○			○			
	Under-voltage trip (UVT)	—		○		○		○			○			
	External handle (EH)	—		●		●		●			●			
	Terminal cover (TC)	●		●		●		●			●			
Trip Unit		Hydraulic magnetic		Hydraulic magnetic		Hydraulic magnetic		Hydraulic magnetic			Hydraulic magnetic			
Tripping button		—		Equipped		Equipped		Equipped			Equipped			

Note 1. "●" which can be installed by client, "○" which have to be installed by manufacturer. "—" which is not available.
 Above accessories table is for 3P breaker.
 2. Ics= 50% Icu
 3. Adjustable thermal: 80%~100% In.

80% ~ 100% Adj. (A)

60	100				
BM60-HBN	BM100-MN	BM100-SN	BM100-HN	BM100-HBN	BM100-H
					
10, 15, 20, 30, 40, 50, 60.	10, 15, 20, 30, 40, 50, 60, 75, 100.	10, 15, 20, 30, 40, 50, 60, 75, 100.	10, 15, 20, 30, 40, 50, 60, 75, 100.	40, 50, 63, 80, 100.	15, 20, 30, 40, 50, 60, 75, 100.
3	2 3	2 3	2 3 4	3 4	3
690	690	690	690	690	690
250	250	250	250	250	250
90	50 75	50 75	60 90 120	105 140	105
155	130	130	155	165	165
68	68	68	68	68	86
90	90	90	90	92	112
134	111	111	134	126	126
30	25	25	30	35	35
1.3	0.45 0.65	0.45 0.65	0.9 1.3 1.6	1.5 1.9	2.1
15	5	5	15	20	25
25	7.5	10	25	32	42
30	10	15	30	36	50
50	15	25	50	85	85
—	—	—	—	—	—
—	—	—	—	—	—
Clamp terminal	Clamp terminal	Clamp terminal	Clamp terminal	Clamp terminal	Clamp terminal
○	○	○	○	●	○
○	○	○	○	●	○
○	○	○	○	●	○
○	○	○	○	●	—
●	●	●	●	●	●
●	●	●	●	●	●
Hydraulic magnetic	Hydraulic magnetic	Hydraulic magnetic	Hydraulic magnetic	Adj. thermal Fixed magnetic	Thermal magnetic
Equipped	Equipped	Equipped	Equipped	Equipped	Equipped

Index

MCCB
ELCB

ATS

ACB

MCB





SPD

MS

MMS

MCCB (Molded Case Circuit Breaker)



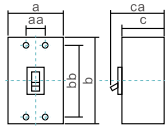



80% ~ 100% Adj. (A)

Frame size (AF) (Inm)		100		125			160							
Type		BM100-HC		BM100-HS		BM125-SN			BM125-HN			BM160-SN		
Photograph														
Rated current In (A) at ambient temp. 40°C		40, 50, 63, 80, 100.		40, 50, 63, 80, 100.		10, 15, 20, 30, 40, 50, 60, 75, 100, 125.			10, 15, 20, 30, 40, 50, 60, 75, 100, 125.			125, 140, 160.		
Number of poles (P)		3	4	3	4	2	3	4	2	3	4	3	4	
Rated insulation voltage Ui (V)		AC		690		690			690			690		
		DC		250		250			—			250		
Dimensions		a	105	140	105	140	60	90	120	60	90	120	105	140
		b	165		165		155			155			165	
		c	86		86		68			68			68	
		ca	112		112		90			90			92	
		bb	126		126		132			132			126	
		aa	35		35		30			30			35	
		(mm)												
Weight (kg)		2.1	2.6	2.1	2.6	0	30	30	0	30	30	1.5	1.9	
Rated breaking capacity (kA)	IEC 60947-2 EN 60947-2 Icu	AC	500V	42	50	7.5			15			15		
		AC	440V	55	70	15			25			25		
			380V	70	85	22			30			30		
			220V(240V)	100	125	30			50			50		
	DC	250V	—	—	—			—			—			
		125V	—	—	—			—			—			
Connection		Clamp terminal		Clamp terminal		Clamp terminal			Clamp terminal			Clamp terminal		
Optional accessories	Alarm switch (AL)	○	○	○	○	○	○	○	○	○	○	○	○	
	Auxiliary switch (AX)	○	○	○	○	○	○	○	○	○	○	○	○	
	Shunt trip (SHT)	○	○	○	○	○	○	○	○	○	○	○	○	
	Under-voltage trip (UVT)	—	—	—	—	○	○	—	○	○	○	○	○	
	External handle (EH)	●	●	●	●	●	●	●	●	●	●	●	●	
	Terminal cover (TC)	●	●	●	●	●	●	●	●	●	●	●	●	
	Trip Unit	Thermal magnetic		Thermal magnetic		Hydraulic magnetic			Hydraulic magnetic			Adj. thermal Fixed magnetic		
Tripping button	Equipped		Equipped		Equipped			Equipped			Equipped			

Note 1. "●" which can be installed by client, "○" which have to be installed by manufacturer. "—" which is not available.
 Above accessories table is for 3P breaker.
 2. Ics= 50% Icu
 3. Adjustable thermal: 80%~100% In.

80% ~ 100% Adj. (A)

80% ~ 100% Adj. (A)

160				250								
BM160-HN		BM160-HB		BM160-HC		BM160-HS		BM250-CN			BM250-SN	
												
125, 140, 160.		125, 140, 160.		125, 140, 160.		125, 140, 160.		125, 150, 175, 200, 225, 250.			175, 200, 225, 250.	
3	4	3	4	3	4	3	4	2	3	4	3	4
690		690		690		690		690			690	
250		250		250		250		250	—	—	250	
105	140	105	140	105	140	105	140	105	105	140	105	140
165		165		165		165		165			165	
68		86		86		86		68			68	
92		112		112		112		92			92	
126		126		126		126		126			126	
35		35		35		35		35			35	
1.5	1.9	2.1	2.6	2.1	2.6	2.1	2.6	1.3	1.5	1.9	1.5	1.9
20		25		42		50		7.5			15	
32		42		55		70		15			25	
36		50		70		85		22			30	
85		85		100		125		30			50	
—		—		—		—		10	—	—	—	
—		—		—		—		15	—	—	—	
Clamp terminal		Clamp terminal		Clamp terminal		Clamp terminal		Clamp terminal			Clamp terminal	
●		○		○		○		●			●	
●		○		○		○		●			●	
●		○		○		○		●			●	
●		—		—		—		●			●	
●		●		●		●		●			●	
●		●		●		●		●			●	
Adj. thermal Fixed magnetic		Thermal magnetic		Thermal magnetic		Thermal magnetic		Adj. thermal Fixed magnetic			Adj. thermal Fixed magnetic	
Equipped		Equipped		Equipped		Equipped		Equipped			Equipped	

Index

MCCB
ELCB

ATS

ACB

MCB





SPD

MS





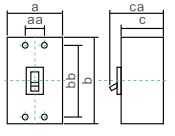

MMS

MCCB (Molded Case Circuit Breaker)

80% ~ 100% Adj. (A)

Frame size (AF) (Inm)		250								400				
Type		BM250-HN		BM250-HB		BM250-HC		BM250-HS		BM400-CN				
Photograph														
Rated current In (A) at ambient temp. 40°C		175, 200, 225, 250.		125, 150, 175, 200, 225, 250.		175, 200, 225, 250.		175, 200, 225, 250.		250, 300, 350, 400.				
Number of poles (P)		3	4	3	4	3	4	3	4	2	3	4		
Rated insulation voltage Ui (V)		AC		690		690		690		690				
		DC		250		250		250		250		—	—	
Dimensions		a		105	140	105	140	105	140	105	140	140	140	185
		b		165		165		165		165		257		
		c		68		86		86		86		103		
		ca		92		112		112		112		155		
		bb		126		126		126		126		194		
		aa		35		35		35		35		44		
		(mm)												
Weight (kg)		1.5	1.9	2.1	2.6	2.1	2.6	2.1	2.6	5.0	5.7	7.5		
Rated breaking capacity (kA)	IEC 60947-2 EN 60947-2 AC	500V	20		25		42		50		14			
		440V	32		42		55		70		22			
		380V	36		50		70		85		25			
		220V(240V)	85		85		100		125		35			
	DC	250V	—		—		—		—		10	—	—	
		125V	—		—		—		—		15	—	—	
Connection		Clamp terminal		Clamp terminal		Clamp terminal		Clamp terminal		Busbar				
Optional accessories	Alarm switch (AL)	●		○		○		○		●				
	Auxiliary switch (AX)	●		○		○		○		●				
	Shunt trip (SHT)	●		○		○		○		●				
	Under-voltage trip (UVT)	●		—		—		—		●				
	External handle (EH)	●		●		●		●		●				
	Terminal cover (TC)	●		●		●		●		●				
Trip Unit		Adj. thermal Fixed magnetic		Thermal magnetic		Thermal magnetic		Thermal magnetic		Thermal magnetic				
Tripping button		Equipped		Equipped		Equipped		Equipped		Equipped				

Note 1. "●" which can be installed by client, "○" which have to be installed by manufacturer. "—" which is not available.
 Above accessories table is for 3P breaker.
 2. Ics= 50% Icu
 3. Adjustable thermal: 80%~100% In.

400				630							
BM400-SN		BM400-HN		BM400-RN		BM400-UN		BM630-CN		BM630-SN	
											
250, 300, 350, 400.		250, 300, 350, 400.		250, 300, 350, 400.		250, 300, 350, 400.		500, 600, 630.		500, 630.	
3	4	3	4	3	4	3	4	3	3	4	4
690		690		690		690		690		690	
250		250		250		250		250		250	
140	185	140	185	140	185	140	185	210	210	280	280
257		257		257		257		275		275	
103		103		103		103		103		103	
155		155		155		155		155		155	
194		194		194		194		243		243	
44		44		44		44		70		70	
5.7	7.5	5.7	7.5	5.7	7.5	5.7	7.5	10	10	13	13
20		25		42		65		14		20	
30		42		55		85		22		30	
35		50		70		85		25		35	
50		85		100		125		35		50	
—		—		—		—		10		20	
—		—		—		—		—		—	
Busbar		Busbar		Busbar		Busbar		Busbar		Busbar	
●	●	●	●	●	●	●	●	●	●	●	●
●	●	●	●	●	●	●	●	●	●	●	●
●	●	●	●	●	●	●	●	●	●	●	●
●	●	●	●	●	●	●	●	●	●	●	●
●	●	●	●	●	●	●	●	●	●	●	●
●	●	●	●	●	●	●	●	●	●	●	●
Thermal magnetic		Thermal magnetic		Thermal magnetic		Thermal magnetic		Fixed thermal Adj. magnetic		Fixed thermal Adj. magnetic	
Equipped		Equipped		Equipped		Equipped		Equipped		Equipped	

Index

MCCB
ELCB

ATS

ACB

MCB

SPD





MS

MMS

MCCB (Molded Case Circuit Breaker)

Frame size (AF) (Inm)		630				800						
Type		BM630-HN		BM630-RN		BM630-UN		BM800-CN		BM800-SN		
Photograph												
Rated current In (A) at ambient temp. 40°C		500, 630.		500, 630.		500, 630.		700, 800.		700, 800.		
Number of poles (P)		3	4	3	4	3	4	3	4	3	4	
Rated insulation voltage Ui (V)		AC		690		690		690		690		
		DC		250		250		250		250		
Dimensions		a		210	280	210	280	210	280	210	280	
		b		275		275		275		275		
		c		103		103		103		103		
		ca		155		155		155		155		
		bb		243		243		243		243		
		aa		70		70		70		70		
Weight (kg)		10	13	10	13	10	13	10.5	13.5	10.5	13.5	
Rated breaking capacity (kA)	IEC 60947-2 EN 60947-2 AC	500V	25		42		65		20		25	
		440V	50		70		85		30		50	
		380V	50		70		100		35		50	
		220V(240V)	85		100		125		50		85	
	DC	250V	40	—	—	—	—	—	20	—	40	—
		125V	—	—	—	—	—	—	—	—	—	—
Connection		Busbar		Busbar		Busbar		Busbar		Busbar		
Optional accessories	Alarm switch (AL)	●		●		●		●		●		
	Auxiliary switch (AX)	●		●		●		●		●		
	Shunt trip (SHT)	●		●		●		●		●		
	Under-voltage trip (UVT)	●		●		●		●		●		
	External handle (EH)	●		●		●		●		●		
	Terminal cover (TC)	●		●		●		●		●		
Trip Unit		Fixed thermal Adj. magnetic		Fixed thermal Adj. magnetic		Fixed thermal Adj. magnetic		Fixed thermal Adj. magnetic		Fixed thermal Adj. magnetic		
Tripping button		Equipped		Equipped		Equipped		Equipped		Equipped		

Note 1 "●" which can be installed by client, "○" which have to be installed by manufacturer. "—" which is not available.
 Above accessories table is for 3P breaker.
 2. Ics= 50% Icu

800		1000		1200		1600			
BM800-HN		BM800-RN		BM1000-HS		BM1200-HS		BM1600-HS	
									
700, 800.		700, 800.		1000		1200		1400, 1600.	
3	4	3	4	3	3	3	3	3	3
690		690		690		690		690	
250		250		—		—		—	
210	280	210	280	210	210	210	210	210	210
275		275		406		406		406	
103		103		140		140		140	
155		155		190		190		190	
243		243		375		375		375	
70		70		70		70		70	
10.5	13.5	10.5	13.5	23	23	23	23	23	23
42		65		65		65		65	
70		85		85		85		85	
70		100		100		100		100	
100		125		130		130		130	
—		—		—		—		—	
—		—		—		—		—	
Busbar		Busbar		Busbar		Busbar		Busbar	
●		●		○		○		○	
●		●		○		○		○	
●		●		○		○		○	
●		●		○		○		○	
●		●		—		—		—	
●		●		—		—		—	
Fixed thermal Adj. magnetic		Fixed thermal Adj. magnetic		Fixed thermal Adj. magnetic		Fixed thermal Adj. magnetic		Fixed thermal Adj. magnetic	
Equipped		Equipped		Equipped		Equipped		Equipped	

Index

MCCB
ELCB

ATS

ACB

MCB

SPD

MS

MMS

EMCCB (Electronic Molded Case Circuit Breaker)

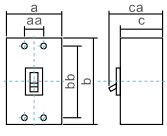
Frame size (AF) (Inm)		100			160			250			
Type		BM100-HE	BM100-RE	BM100-UE	BM160-HE	BM160-RE	BM160-UE	BM250-HE	BM250-RE	BM250-UE	
Rated current In (A) at ambient temp. 40°C		100			160			250			
Electronically adjustable current Ir (A)		40, 45, 50, 60, 70, 80, 90, 95, 100.			64, 72, 80, 96, 112, 128, 144, 152, 160.			100, 113, 125, 150, 175, 200, 225, 238, 250.			
Rated operational voltage Ue (V)		400			400			400			
Rated insulation voltage Ui (V)		690			690			690			
Rated impulse withstand voltage Uimp (V)		8000			8000			8000			
Number of poles (P)		3P / 4P			3P / 4P			3P / 4P			
Model		HE	RE	UE	HE	RE	UE	HE	RE	UE	
Rated breaking capacity Icu (kA)		50	70	85	50	70	85	50	70	85	
Dimensions (mm)	 <p>(mm)</p>	a	105 / 140			105 / 140			105 / 140		
		b	165			165			165		
		c	86			86			86		
		ca	112			112			112		
		bb	126			126			126		
		aa	35			35			35		
Weight (kg)		2.5 / 3.0			2.5 / 3.0			2.5 / 3.0			
Endurance	Electrical life (10 thousand)	1,000			1,000			1,000			
	Mechanical life (10 thousand)	8,500			7,000			7,000			
Connection		Clamp terminal			Clamp terminal			Clamp terminal			
Trip unit		Electronic			Electronic			Electronic			
Trip button		Equipped			Equipped			Equipped			
Optional accessories	Alarm switch (AL)	○			○			○			
	Auxiliary switch (AX)	○			○			○			
	Shunt trip (SHT)	○			○			○			
	Under-voltage trip (UVT)	—			—			—			
	Lead wiring terminal (LT)	○			○			○			
	Motor operation device	○			○			○			
	Communication (COM)	○			○			○			
	Communication (HUB)	○			○			○			

Note 1. Ics= 50% Icu

400			630			800			1000		1250	
BM400-HE	BM400-RE	BM400-UE	BM630-HE	BM630-RE	BM630-UE	BM800-SE	BM800-HE	BM800-RE	BM1000-SE	BM1000-HE	BM1250-SE	BM1250-HE
400			630			800			1000		1250	
160, 180, 200, 240, 280, 320, 360, 380, 400.			252, 284, 315, 378, 441, 504, 567, 600, 630.			320, 360, 400, 480, 560, 640, 720, 760, 800.			400, 450, 500, 600, 700, 800, 900, 950, 1000.		500, 563, 625, 750, 875, 1000, 1125, 1188, 1250.	
400			400			400			400		400	
690			690			690			690		690	
8000			8000			8000			8000		8000	
3P / 4P			3P / 4P			3P / 4P			3P		3P	
HE	RE	UE	HE	RE	UE	SE	HE	RE	SE	HE	SE	HE
50	70	85	50	70	85	50	70	85	70	85	70	85
140 / 185			210 / 280			210 / 280			210		210	
257			275			275			406		406	
103			103			103			140		140	
144			155			155			190		190	
194			243			243			375		375	
44			70			70			70		70	
7 / 8			11.5 / 14.5			11.5 / 14.5			26		26	
1, 000			1, 000			500			500		500	
4, 000			4, 000			2, 500			2, 500		2, 500	
Busbar			Busbar			Busbar			Busbar		Busbar	
Electronic			Electronic			Electronic			Electronic		Electronic	
Equipped			Equipped			Equipped			Equipped		Equipped	
○			○			○			—		—	
○			○			○			—		—	
○			○			○			—		—	
○			○			○			—		—	
—			—			—			—		—	
○			○			○			—		—	
○			○			○			—		—	
○			○			○			—		—	

Index

MCCB
ELCB

ATS

ACB



MCB

SPD

MS



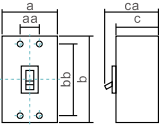

MMS

ELCB (Earth Leakage Circuit Breaker)

Frame size (AF) (Inm)		50		100					
Type		BL50-SN		BL100-SN		BL100-HN			
Photograph									
Rated current In (A) at ambient temp. 40°C		15, 20, 30, 40, 50.		15, 20, 30, 40, 50, 60, 75, 100.		15, 20, 30, 40, 50, 60, 75, 100.			
Phase & wire (P)		1ø2W, 3ø3W.	3ø4W	1ø2W, 3ø3W.	3ø4W	1ø2W, 3ø3W.	3ø4W		
Number of poles (P)		3	4	3	4	3	4		
Rated voltage (VAC)		230, 400.		230, 400.		230, 400.			
High speed	Rated current sensitivity IΔn (mA)	30, 100, 300, 500 (Note 2)		30, 100, 300, 500 (Note 2)		30, 100, 300, 500 (Note 2)			
	5IΔn operating time (S)	0.04		0.04		0.04			
Delay	Rated current sensitivity IΔn (mA)	100- 300- 500 adjustable		100- 300- 500 adjustable		100- 300- 500 adjustable			
	2IΔn operating time (S)	0.1- 0.4- 0.8- 2.0 adjustable		0.1- 0.4- 0.8- 2.0 adjustable		0.1- 0.4- 0.8- 2.0 adjustable			
	2IΔn max. non-operating time (S)	0, 0.2, 0.4, 1.0		0, 0.2, 0.4, 1.0		0, 0.2, 0.4, 1.0			
	Leakage detection mode	Mechanical push-button		Mechanical push-button		Mechanical push-button			
Dimensions		a	75	100	90	120	90	120	
		b	130		155		155		
		c	68		68		68		
		ca	90		90		90		
		bb	111		132		132		
		aa	25		30		30		
Weight (kg)		0.7	0.9	1.5	1.8	1.5	1.8		
SPD	Rated breaking capacity (kA)	AC	IEC 60947-2	440V	7.5	10	25		
			EN 60947-2	380V	7.5	15	30		
			CNS 14816-2	220V	10	25	50		
MS	Optional accessories	Connection		Clamp terminal		Clamp terminal		Clamp terminal	
		Alarm switch	(AL)	○	○	○	○		
		Auxiliary switch	(AX)	○	○	○	○		
		Shunt trip	(SHT)	○	○	○	○		
		Under-voltage trip	(UVT)	—	○	○	○		
		External handle	(EH)	●	●	●	●		
		Terminal cover	(TC)	●	●	●	●		
		Leakage alarm module	(AM)	—	○	○	○		
Trip Unit		Hydraulic magnetic		Hydraulic magnetic		Hydraulic magnetic			
Tripping button		Equipped		Equipped		Equipped			

Note 1. "●" which can be installed by client, "○" which have to be installed by manufacturer. "—" which is not available.
 2. Specify rated current sensitivity when place the order.
 3. Ics= 50% Icu
 4. Adjustable thermal: 80%~100% In.

80% ~ 100% Adj. (A)

160		250		400			
BL160-SN		BL250-SN		BL400-SN	BL400-HN	BL400-RN	
							
125, 140, 160.		175, 200, 225, 250.		250, 300, 350, 400.		250, 300, 350, 400.	
1ø2W, 3ø3W.	3ø4W	1ø2W, 3ø3W.	3ø4W	1ø2W, 3ø3W.	3ø4W	1ø2W, 3ø3W.	3ø4W
3	4	3	4	3	4	3	4
230, 400.		230, 400.		230, 400.		230, 400.	
30, 100-300-500 Adj.		30- 100- 500 adjustable		30- 100- 500 adjustable		30- 100- 500 adjustable	
0.04		0.04		0.04		0.04	
100- 300- 500 adjustable		100- 300- 500 adjustable		100- 300- 500 adjustable		100- 300- 500 adjustable	
0.1- 0.4- 0.8- 2.0 adjustable		0.1- 0.4- 0.8- 2.0 adjustable		0.1- 0.4- 0.8- 2.0 adjustable		0.1- 0.4- 0.8- 2.0 adjustable	
0, 0.2, 0.4, 1.0		0, 0.2, 0.4, 1.0		0, 0.2, 0.4, 1.0		0, 0.2, 0.4, 1.0	
Mechanical push-button		Mechanical push-button		Mechanical push-button		Mechanical push-button	
105	140	105	140	140	185	140	185
165		165		257		257	
68		68		103		103	
92		92		155		155	
126		126		194		194	
35		35		44		44	
1.7	2.3	1.7	2.3	6.6	8.4	6.6	8.4
25		25		30		42	
30		30		35		50	
50		50		50		85	
Clamp terminal		Clamp terminal		Busbar		Busbar	
●		●		●		●	
●		●		●		●	
●		●		●		●	
●		●		●		●	
●		●		●		●	
●		●		●		●	
○		○		○		○	
Adj. thermal Fixed magnetic		Adj. thermal Fixed magnetic		Thermal magnetic		Thermal magnetic	
Equipped		Equipped		Equipped		Equipped	

Index

MCCB
ELCB

ATS

ACB



MCB

SPD



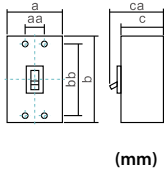

MS

MMS

ELCB (Earth Leakage Circuit Breaker)

Frame size (AF) (Inm)		400		630				
Type		BL400-UN		BL630-HN		BL630-RN		
Photograph								
Rated current In (A) at ambient temp. 40°C		250, 300, 350, 400.		500, 630.		500, 630.		
Phase & wire (P)		1ø2W, 3ø3W.	3ø4W	1ø2W, 3ø3W.	3ø4W	1ø2W, 3ø3W.	3ø4W	
Number of poles (P)		3	4	3	4	3	4	
Rated voltage (VAC)		230, 400.		230, 400.		230, 400.		
High speed	Rated current sensitivity IΔn (mA)	30- 100- 500 adjustable		100- 300- 500 adjustable		100- 300- 500 adjustable		
	5IΔn operating time (S)	0.04		0.04		0.04		
Delay	Rated current sensitivity IΔn (mA)	100- 300- 500 adjustable		100- 300- 500 adjustable		100- 300- 500 adjustable		
	2IΔn operating time (S)	0.45- 1.0- 2.0 adjustable		0.45- 1.0- 2.0 adjustable		0.45- 1.0- 2.0 adjustable		
	2IΔn max. non-operating time (S)	0.1, 0.5, 1.0		0.1, 0.5, 1.0		0.1, 0.5, 1.0		
	Leakage detection mode	Mechanical push-button		Mechanical push-button		Mechanical push-button		
Dimensions		a	140	185	210	280	210	280
		b	257		257		257	
		c	103		103		103	
		ca	155		155		155	
		bb	194		243		243	
		aa	44		70		70	
Weight (kg)		5.7	7.5	10.0	13.0	10.0	13.0	
SPD	Rated breaking capacity (kA)	AC	IEC 60947-2	440V	85	50	70	
			EN 60947-2	380V	85	50	70	
			CNS 14816-2	220V	125	85	100	
Connection		Busbar		Busbar		Busbar		
Optional accessories	Alarm switch (AL)	●		●		●		
	Auxiliary switch (AX)	●		●		●		
	Shunt trip (SHT)	●		●		●		
	Under-voltage trip (UVT)	●		●		●		
	External handle (EH)	●		●		●		
	Terminal cover (TC)	●		●		●		
	Leakage alarm module (AM)	○		○		○		
Trip Unit		Thermal magnetic		Fixed thermal Adj. magnetic		Fixed thermal Adj. magnetic		
Tripping button		Equipped		Equipped		Equipped		

Note 1. "●" which can be installed by client, "○" which have to be installed by manufacturer. "—" which is not available.
 2. Ics= 50% Icu

630		800					
BL630-UN		BL800-SN		BL800-HN		BL800-RN	
							
500, 630.		700, 800.		700, 800.		700, 800.	
1ø2W, 3ø3W.	3ø4W	1ø2W, 3ø3W.	3ø4W	1ø2W, 3ø3W.	3ø4W	1ø2W, 3ø3W.	3ø4W
3	4	3	4	3	4	3	4
230, 400.		230, 400.		230, 400.		230, 400.	
100- 300- 500 adjustable		100- 300- 500 adjustable		100- 300- 500 adjustable		100- 300- 500 adjustable	
0.04		0.04		0.04		0.04	
100- 300- 500 adjustable		100- 300- 500 adjustable		100- 300- 500 adjustable		100- 300- 500 adjustable	
0.45- 1.0- 2.0 adjustable		0.45- 1.0- 2.0 adjustable		0.45- 1.0- 2.0 adjustable		0.45- 1.0- 2.0 adjustable	
0.1, 0.5, 1.0		0.1, 0.5, 1.0		0.1, 0.5, 1.0		0.1, 0.5, 1.0	
Mechanical push-button		Mechanical push-button		Mechanical push-button		Mechanical push-button	
210	280	210	280	210	280	210	280
257		257		257		257	
103		103		103		103	
155		155		155		155	
243		243		243		243	
70		70		70		70	
10.0	13.0	10.5	13.5	10.5	13.5	10.5	13.5
85		50		70		85	
100		50		70		100	
125		85		100		125	
Busbar		Busbar		Busbar		Busbar	
●		●		●		●	
●		●		●		●	
●		●		●		●	
●		●		●		●	
●		●		●		●	
●		●		●		●	
○		○		○		○	
Fixed thermal Adj. magnetic		Fixed thermal Adj. magnetic		Fixed thermal Adj. magnetic		Fixed thermal Adj. magnetic	
Equipped		Equipped		Equipped		Equipped	

Index

MCCB
ELCB

ATS

ACB

MCB

SPD

MS

MMS

Miniature Circuit Breaker | Bolt on type

Frame (AF)		100			50			100			50			100		
Type		BP			BPH			BKH			BKS					
Photograph																
Rated Voltage (A.C) #1		110	220*	220	110	220*	220	110/220*	380	110/220*	220					
Rated Current In (A) At Ambient Temp. 40°C		10*, 15, 20, 30, 40, 50, 60, 75, 100.			15, 20, 30, 40, 50.			15, 20, 30, 40, 50, 60, 75, 100.			15, 20, 30, 40, 50, 60, 75, 100.					
Number of poles (P)		1	2	3	1	2	3	1	2	3	1	2	3			
Dimensions		a	25	50	75	25	50	75	25	50	75	25	50	75		
		b	95			95			95			95				
		c	58.5			58.5			58.5			58.5				
		ca	77.5			77.5			77.5			77.5				
		bb	100			100			100			100				
		aa	0	25	50	0	25	50	0	25	50	0	25	50		
		Weight (kg)	0.15	0.31	0.46	0.2	0.4	0.6	0.22	0.44	0.66	0.22	0.44	0.66		
Rated Breaking Capacity (kA) CNS 14816-2 Icu AC #2 #3	110V / 120V*	5	—	—	10	—	—	15	—	—	25/22**	—				
	220V / 240V*	—	5***	5	—	10	10	10	15	—	—	25/22**				
	380V / 400V*	—	—	—	—	—	—	—	10	—	—	—				
Trip Unit		Thermal Magnetic			Thermal Magnetic			Thermal Magnetic			Thermal Magnetic					

Miniature Circuit Breaker | Plug in type

Frame (AF)		50			100			50			100			
Type		BL			BLH			BLS			BKL			
Photograph														
Rated Voltage (A.C) #1		110/220*	220	110/220*	220	110/220*	220	110/220*	380					
Rated Current In (A) At Ambient Temp. 40°C		15, 20, 30 40, 50.	15, 20, 30, 40, 50 60, 75, 100.	15, 20, 30 40, 50.	15, 20, 30, 40, 50.	15, 20, 30, 40, 50.	60, 75, 100.	15, 20, 30 40, 50.	15, 20, 30, 40, 50 60, 75, 100.					
Number of poles (P)		1	2	3	1	2	3	2	3	1	2	3		
Dimensions		a	25	50	75	25	50	75	50	75	25	50	75	
		b	74			74			74			79		
		c	60.5			60.5			60.5			61		
		ca	74			74			74			77.5		
		bb	—			—			—			—		
		aa	0	25	50	0	25	50	25	50	0	25	50	
		Weight (kg)	0.13	0.26	0.39	0.13	0.26	0.39	0.33	0.53	0.18	0.36	0.54	
Rated Breaking Capacity (kA) CNS 14816-2 Icu AC	110V / 120V*	5	—	—	10	—	—	15	—					
	220V / 240V*	—	5	—	—	10	10	10	15					
	380V / 400V*	—	—	—	—	—	—	—	10					
Trip Unit		Thermal Magnetic			Thermal Magnetic			Thermal Magnetic			Thermal Magnetic			

Note 1. "*/" 1 phase 3 wiring; L-L: 220V, L-N: 110V.
 2. "*/" Rated Breaking Capacity: asym/sym.
 3. "****" BP 1P 220V 5kA Rated Current:15, 20, 30, 40, 50A.

ELCB (Earth Leakage Circuit Breaker) | Earth Leakage, Overload, and Short Circuit Protection

Frame (AF)	50		50		50		50		50		100		50		
Type	BL-50L		BL-50UL		BLP-50L		BLP-50UL		BL-50F		BL-50U		BL-100U		
Photograph															
Rated Current In (A) At Ambient Temp. 40°C	15, 20, 30, 40, 50.														
Phase & Wire	1φ2W														
Number of poles (P)	2P1E	2P2E	2P1E	2P2E	2P1E	2P2E	2P1E	2P2E	2P1E	2P2E	2P1E	2P2E	2P1E	2P2E	
Rated Voltage (A.C.) #1.	110	220	220***	220	110	220	220***	220	110	110~220	110	110~220	220***	220/380	
Rated Current Sensitivity (mA) #2.	30, (100, 200, 300, 500)*				30				30, (100, 200, 300, 500)*						
Max. Operating Time (s)	≤0.15														
Rated Breaking Capacity (kA) CNS 5422 Icu AC	110V	5	—	10	—	5	—	10	—	5	—	10	—	15	—
	220V	—	5	5	10	—	5	5	10	—	5	—	10	10	15
Dimensions 	a	25	50	25	50	25	50	25	50	50	75	50	75	50	75
	b	110				92				95					
	c	60				60.5				58.5					
	ca	78.4				78.4				77.5					
	bb	120				—				100					
	aa	0	25	0	25	0	25	0	25	25	50	25	50	25	50
Weight (kg)	0.22	0.39	0.22	0.39	0.2	0.34	0.2	0.34	0.31	0.46	0.37	0.54	0.4	0.58	
Trip Unit	Thermal Magnetic														
Earth Leakage Tripping Device	Mechanical														

ELCB (Earth Leakage Circuit Breaker)

Frame (AF)	Earth Leakage, Overload Protection				Earth Leakage Protection			
	30		40		30		30	
Type	BL-KLF		BL-KF		BL-K30F		BL-BF	
Photograph								
Rated Current In(A) At Ambient Temp. 40°C	15, 20, 30		15, 20, 30, 40		15, 20, 30		15, 20, 30, 40	
Phase & Wire	1φ2W		1φ2W		1φ3W 3φ3W		1φ2W	
Poles (P)	2P1E	2P2E	2		3		2	
Rated Voltage (A.C.)	110~220		110~220		110~220	380~440	110~220	
Rated Current Sensitivity (mA) #2.	30		30, (100, 200, 300, 500)*		30		30, (100, 200, 300, 500)*	
Max. Operating Time (s)	≤0.15		≤0.15		≤0.15		≤0.15	
Rated Breaking Capacity (kA) CNS 5422 Icu AC	110V~220V	1.5	1.5, 2.5		1.5	—	1.5, 2.5	
	380V~480V	—	—		—	1.5	—	
Dimensions 	a	66		90		32		
	b	70		70		70		
	c	42		42		36		
	ca	60		60		48		
	bb	59		59		62		
	aa	33		57		—		
Weight (kg)	0.2		0.25		0.1			
Trip Unit	Thermal Magnetic				—			
Earth Leakage Tripping Device	Mechanical				Mechanical			

Note 1. "***" 3 phase 4 wiring, L-N: 220V
2. "*" Special order.

Optional Accessories Installation Table

■ AL: Alarm Switch / AX: Auxiliary Switch / SHT: Shunt Trip / UVT: Under Voltage Trip

Model	Poles	AL	AX	SHT or UVT	AL+AX	AL+ SHT or UVT	AX+ SHT or UVT	AL+AX+ SHT or UVT
BM30-SN BM60-SN/ HN BM100-SN / MN	3P							—
BL50-SN	3P 4P			 (#1.)	—	—	—	—
BM60-HBN BM100-HN BM125-SN	3P 4P			 (3P) (4P)		 (3P) (4P)	 (3P) (4P)	—
BL100-SN BL100-HN	3P 4P			 No UVT for 3P	—	 (#2.)	 (#2.)	—
BM100-H/ HC/ HS BM160-HB/ HC/ HS BM250-HB/ HC/ HS	3P 4P			 (#1.)	 (#1.)	 (#1.)	 (#1.)	—
BM100-HBN BM160-SN/ HN BM250-SN/ HN	3P 4P							
BL160-SN BL250-SN	3P 4P				—	—	—	—
BM400-SN/ HN/ RN/ UN	3P 4P				 AX can be installed in AL position			
BL400-SN/ HN/ RN/ UN	3P 4P				 AX can be installed in AL position			—
BM630-SN/ HN/ RN/ UN BM800-CN/ SN/ HN/ RN	3P 4P				 AX can be installed in AL position			 AX can be installed in AL position
BL630-HN/ RN/ UN BL800-SN/ HN/ RN	3P 4P							
BM1000-HS BM1200-HS BM1600-HS	3P				—			—

Note:

- Standard: AL and AX are installed on left side, SHT and UVT are installed on right side.
- SHT is equipped with coil anti-burn switch.
- BL series can not do right side installation.
- UVT of BM30-SN~BM100-HN can not install on its left side.
- #1 means have no UVT.
- #2 means only can apply to 4P breakers.

● : AL
○ : AX
■ : SHT or UVT

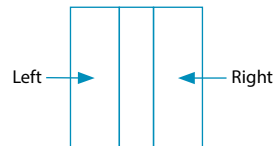

Optional Accessories | Application Table

External Handle

TYPE	Poles	Model
EH-100N	3P、4P	BM30-SN, BM60-SN/HN, BM100-SN/MN, BL50-SN
EH-125N	3P、4P	BM60-HBN, BM100-HN, BM125-SN, BL100-SN/HN
EH-250N	3P、4P	BM100-HBN, BM160-SN/HN, BM250-SN/HN, BL160-SN, BL250-SN
EH-400N	3P、4P	BM400-SN/HN/RN/UN, BL400-SN/HN/RN/UN
EH-800N	3P、4P	BM630-SN/HN/RN/UN, BM800-CN/SN/HN/RN, BL630-HN/RN/UN, BL800-SN/HN/RN
EH-250H	3P、4P	BM100-H/HC/HS, BM160-HB/HC/HS, BM250-HB/HC/HS

Manual Operation Device

TYPE	Poles	Model
MA-100N	3P、4P	BM30-SN, BM60-SN/HN, BM100-SN/MN, BL50-SN
MA-125N	3P、4P	BM60-HBN, BM100-HN, BM125-SN, BL100-SN/HN
MA-250N	3P、4P	BM100-HBN, BM160-SN/HN, BM250-SN/HN, BL160-SN, BL250-SN
MA-400N	3P、4P	BM400-SN/HN/RN/UN, BL400-SN/HN/RN/UN
MA-800N	3P、4P	BM630-SN/HN/RN/UN, BM800-CN/SN/HN/RN, BL630-HN/RN/UN, BL800-SN/HN/RN

Motor Operation Device

TYPE	Poles	Model
MT-100N	3P、4P	BM30-SN, BM60-SN/HN, BM100-SN/MN, BL50-SN
MT-125N	3P、4P	BM60-HBN, BM100-HN, BM125-SN, BL100-SN/HN
MT-250N	3P、4P	BM100-HBN, BM160-SN/HN, BM250-SN/HN, BL160-SN, BL250-SN
MT-400N	3P、4P	BM400-SN/HN/RN/UN, BL400-SN/HN/RN/UN
MT-800N	3P、4P	BM630-SN/HN/RN/UN, BM800-CN/SN/HN/RN, BL630-HN/RN/UN, BL800-SN/HN/RN
MT-250E	3P、4P	BM100-H/HC/HS, BM160-HB/HC/HS, BM250-HB/HC/HS

Note : Applicable voltage : ① DC 24V ② AC 110V/ DC 110V ③ AC 230V/ DC 220V

Rear Connection

TYPE	Poles	Model
PGI-100N50	3P	BM30-SN, BM60-SN/HN, BL50-SN (50A and below)
PGI-100N	3P	BM60-SN/HN, BM100-SN/MN (60A and below)
PGI-125N50	3P	BM60-HBN, BM100-HN, BM125-SN, BL100-SN/HN (50A and below)
	4P	BM100-HN, BM125-SN, BL100-SN/HN (50A and below)
PGI-125N	3P	BM60-HBN, BM100-HN, BM125-SN, BL100-SN/HN (60A and above)
	4P	BM100-HN, BM125-SN, BL100-SN/HN (60A and above)
PGI-250N	3P、4P	BM100-HBN, BM160-SN/HN, BM250-SN/HN, BL160-SN, BL250-SN
PGI-400N	3P、4P	BM400-SN/HN/RN/UN, BL400-SN/HN/RN/UN
PGI-800N	3P、4P	BM630-SN/HN/RN/UN, BM800-CN/SN/HN/RN, BL630-HN/RN/UN, BL800-SN/HN/RN
PGI-BM250	3P	BM100-H/HC/HS, BM160-HB/HC/HS, BM250-HB/HC/HS

Index

MCCB
ELCB

ATS

ACB

MCB

SPD

MS

MMS

Optional Accessories | Dimensions

External Handle

Type	Poles	fig.1			fig.2			fig.3		
		A	B	C	D	E	F	G	H	J
EH-100N	3P, 4P	104	105	39	90	78	10	25	111	M4 screw or $\phi 5$
EH-125N	3P, 4P	104	105	39	90	78	10	30	132	
EH-250N	3P, 4P	104	105	39	90	78	10	35	126	
EH-400N	3P, 4P	150	183	53	108	112	10	44	194	
EH-800N	3P, 4P	150	183	53	108	112	10	70	243	
EH-250H	3P, 4P	104	125	39	90	78	10	35	126.5	

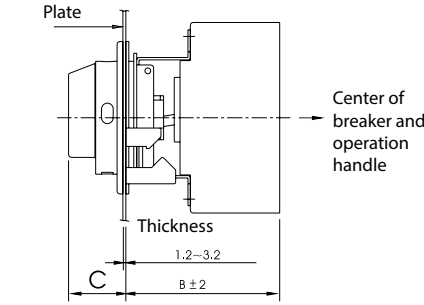
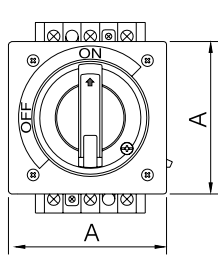
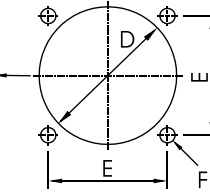
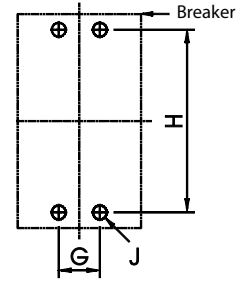

Fig. 1

Center of breaker and operation handle



Panel Dimension
Fig. 2



Breaker Dimension
Fig. 3

- Note: 1. Standard: White, optional: Black.
 2. Optional for dust and water protection.
 3. L: long type, EH100NL & EH125NL can not install to 2P.

Manual Operation Device

Type	Dimensions (mm)			
	A	B	H	Y
MA-100N	111	25	53.5	+8
MA-125N	132	30	54	+8
MA-250N	146	35	56	0
MA-400N	221	45	85	+10
MA-800N	242	70	85	+10

Motor Operation Device

Type	Dimensions (mm)						
	A	B	d	H	K	L	W
MT-100N	25	111	$\phi 4.5$	16.5	79	102	74
MT-125N	30	132	$\phi 4.5$	15	77	116	90
MT-250N	30	126	$\phi 4.5$	15	77	116	90
MT-400N	44	194	$\phi 4.5$	36	115	176	130
MT-800N	70	234	$\phi 4.5$	36	115	176	130
MT-250E	30	126	$\phi 4.5$	15	77	116	90

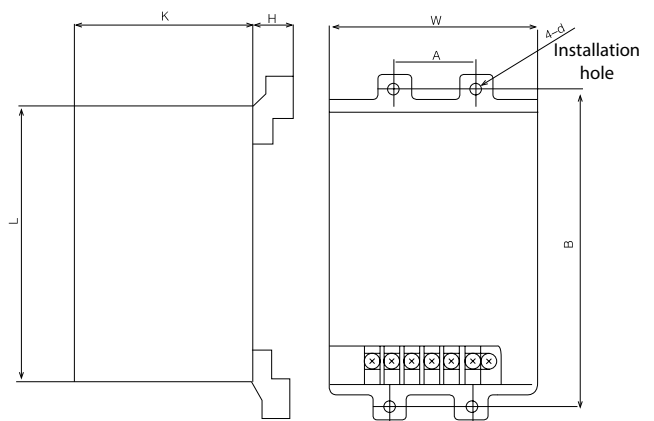
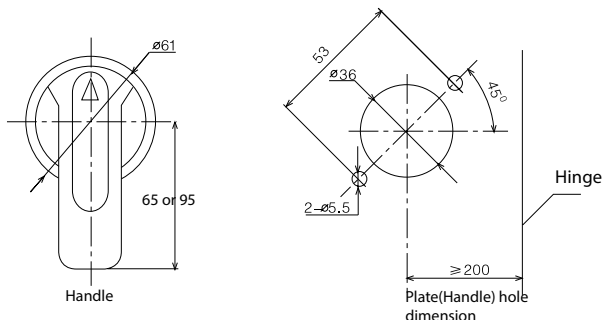
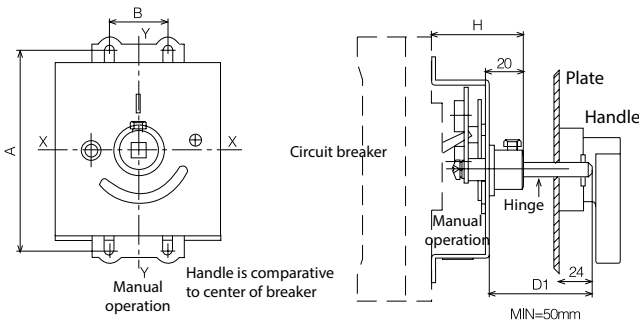

■ Rear Connection

Type	Poles	Dimensions (mm)																	Connect Direction		
		A	A1	B	B1	C	D	D1	E	F	G	H	H1	J	K	K1	K2	L	M	Horizontal	Vertical
PGI-100N	3	74	50	24	58	90	ø5	/	116	M10	9.5	28	12	M10	/	62	122	50	M4	⊙	⊙
	4	99	75															75			
PGI-125N	3	92	60	30	70	104	ø6	/	134	M10	13	26	16	M10	/	62	122	60	M5	⊙	⊙
	4	122	90															90			
PGI-250N	3	107	70	38	76	106	ø6	ø10	144	25	13	34	15	6	/	79	134	70	M5	⊙	⊙
	4	142	105															105			
PGI-400N	3	137	44	50	135	175	ø10	ø13	225	28	18	40	24	8	120	79	/	44	M8	⊙	⊙
	4	181	88															88			
PGI-800N	3	212	140	57	143	185	ø10	ø13	243	44	17	53	20	11	/	146	/	140	M8	⊙	⊙
	4	282	210															210			

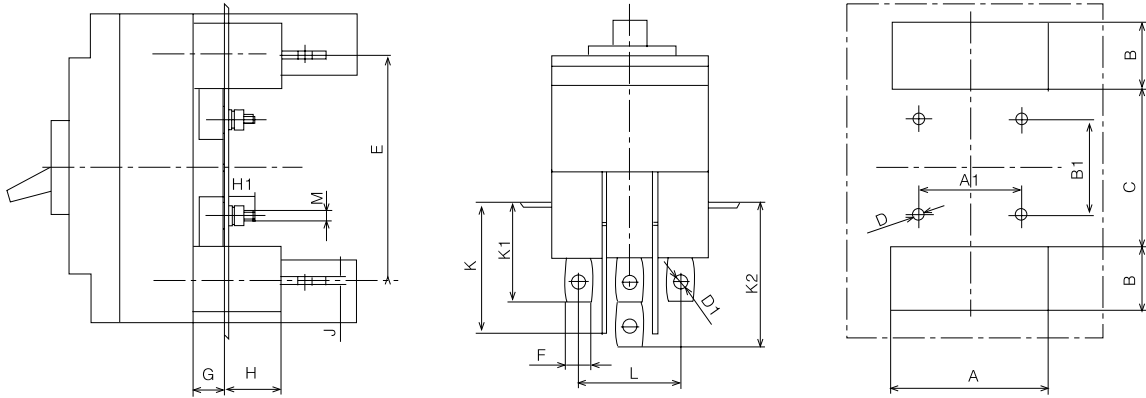

■ Rear Connection

Type	Poles	Dimensions (mm)																	Connect Direction		
		A	A1	B	B1	C	D	D1	E	F	G	H	H1	J	K	K1	K2	L	M	Horizontal	Vertical
PGI-BM250	3	107	70	38	76	106	ø6	ø10	144	25	13	34	15	6	/	79	134	70	M5	⊙	⊙

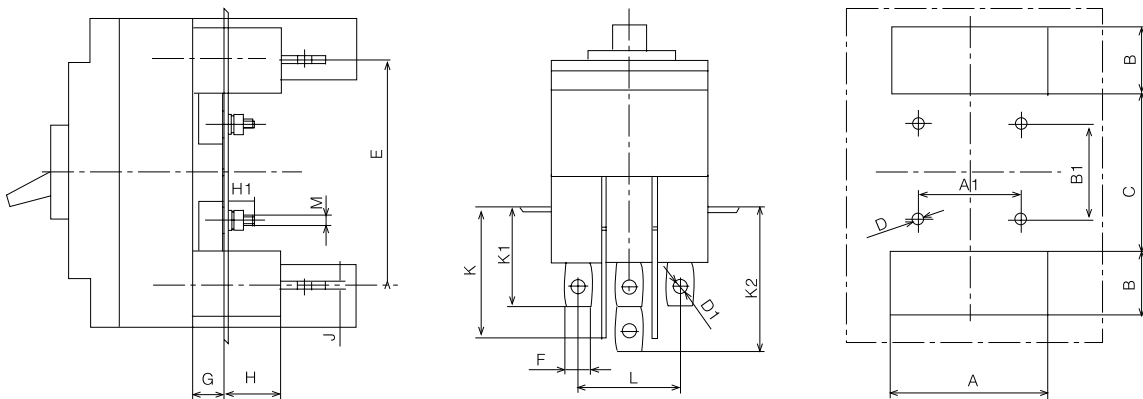

Index

MCCB
ELCB

ATS

ACB

MCB

SPD

MS

MMS



ATS (Automatic Transfer Switches)

A. MCCB Type

(Controller voltage: AC 220V)

Type	Pole	Rated current In (A)	Rated Breaking Capacity Sym r.m.s. (kA) IEC 60947-2 AC Icu	
			220V	380V
BS100SN	2P, 3P, 4P	10, 15, 20, 30, 40, 50, 60, 75, 100.	25	15
BS100HN	2P, 3P, 4P		50	30
BS250SN	2P, 3P, 4P	125, 150, 175, 200, 225, 250.	50	30
BS400SN	2P, 3P, 4P		50	35
BS400HN	2P, 3P, 4P	250, 300, 350, 400.	85	50
BS630SN	3P, 4P		50	35
BS630HN	3P, 4P	500, 600, 630.	85	50
BS800SN	3P, 4P		700, 800.	85
BS1000HS	3P	1000	130	100
BS1200HS	3P	1200	130	100
BS1600HS	3P	1400, 1600.	130	100

Note: 1. Standard: IEC 60947-2
 2. Special breaking capacity, please contact sales representative.
 3. BS225SN rated current 250A is optional order.

Index

MCCB
ELCB

ATS

ACB

MCB

SPD

MS

MMS



B. MS Type

Type	ATS Protection Switch	Rated current In (A)	Pole	Voltage
BS-MB	Miniature Circuit Breaker Protection Switch	20A	R, N	110V
			R, T	220V

ACB (Air Circuit Breaker) | BW Series

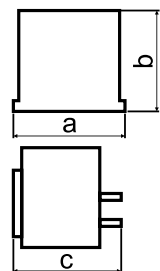
Frame (AF)		2000 - AF				3200 - AF				4000 - AF		6300 - AF				
Type		BW-2000H				BW-3200H				BW-4000H		BW-6300H				
Feature																
Type		Fixed type		Drawout type		Fixed type		Drawout type		Drawout type		Drawout type				
Rated current (In) (A)		630, 800, 1000, 1250, 1600, 2000.				2000, 2500, 3200.				4000.		4000, 5000.		6300.		
Adjustable range of rated current (A)		0.4 ~ 1.0In														
Max. rated voltage (Ue) V (50/60Hz)		AC 690														
Rated insulated voltage (Ui) V (50/60Hz)		AC 1000														
Rated impulse withstand voltage (Uimp) kV		12														
Number of poles		3	4	3	4	3	4	3	4	3	4	3	4	3		
Rated current of N pole (A)		—	100%	—	100%	—	100%	—	100%	—	100%	—	100%	—		
Rated breaking capacity (kA)	IEC 60947-2 CNS 14816-2 Icu/Ics kA	*AC 690V		50/40				65/50				65/50		75/65		
		*AC 440V		75/48				85/55				85/55		100/100		
		*AC 415V		78/50				90/60				90/60		110/100		
		AC 400V		80/50				100/65				100/65		120/100		
		*AC 380V		85/55				100/65				100/65		130/130		
		*AC 220V		150/95				170/110				170/110		200/200		
Rated short time withstand capacity (Icw) kA (1 sec)		50				65				65		100				
Electrical control type	Standard type (M Type)		●													
	Communication type (H Type)		●													
Number of operating cycles		10000														
Bus bar connection type		Horizontal / Vertical				Horizontal						Horizontal				
Dimensions (mm)		Horizontal	a	362	457	375	470	429	544	435	550	435	550	813	928	928
			b	395	395	430	430	398	398	430	430	430	430	435	435	435
			c	332	332	421	421	333	333	421	421	466	466	505	505	505
		Vertical	a	362	457	375	470	—						—		
			b	395	395	430	430	—						—		
			c	356	356	416	416	—						—		
Auxiliary switch (Standard device)		4NO 4NC														
Motor drive		Rated control voltage: AC 110V, 220V, 380V; DC 110V, 220V														
Optional accessory	Under-voltage trip (UVT)		Rated control voltage: AC 110V, 220-230V, 380-400V													
	Manual programming editor		English version													
	ST-DP interface		●													
	ST power module		●													
	Power ZCT		●													

Note: The rated breaking capacity indicated by voltage which marked with * are for reference.

MCB (Miniature Circuit Breaker) | BHA Series

Applications:

Applicable to the residential, industrial and commercial power distribution systems, provide circuit-control and protection on equipments against any impacts of overload, short-circuit and earth leakage.
100AF also can be used for any of the application with low switching.

- DIN rail TH 35mm
- Ambient temperature: -5°C~ +40°C

BHA

- Overload, Short Circuit

BHA	2	2	C	32		
Type	Rated short-circuit breaking capacity (kA) Rated voltage (V)	Poles (P)	Tripping characteristics	Rated current In (A)	Standard	Mechanical life
BHA	2: 4.5kA; 3: 6kA; 4: 10kA 230/400V	1, 2, 3, 4	C type: 5~ 10In D type: 10~ 15In	1, 2, 3, 4, 5, 6, 10, 16, 20, 25, 32, 40, 50, 63.	IEC 60898	20,000 operations
BHA	4: 10kA DC 125V (1P) / DC 250V (2P)	1, 2	DC Type	1, 2, 3, 4, 5, 6, 10, 16, 20, 25, 32, 40, 50, 63.	IEC 60947-2	20,000 operations
BHN	2: 4.5kA; 3: 6kA 230V	1P+N	C type: 5~ 10In	6, 10, 16, 20, 25, 32.	IEC 60898	20,000 operations



Index

MCCB
ELCB

ATS

ACB

MCB

SPD

MS

MMS

BHL

- Overload, Short Circuit, Leakage

BHL	2	2	C	32	32
Type	Rated short-circuit breaking capacity (kA) Rated voltage (V)	Poles (P)	Tripping characteristics	Rated current In (A)	Optional function
BHL	2: 4.5kA; 3: 6kA 230V	1P+N	C type: 5~ 10In D type: 10~ 15In	6, 10, 16, 20, 25, 32, 40.	Over-voltage protection (230V, internal built)
BHL	2: 4.5kA 230V: 2P ; 400V: 3P/4P	2, 3, 4	C type: 5~ 10In D type: 10~ 15In	1, 2, 3, 4, 5, 6, 10, 16, 20, 25, 32, 40, 50, 63.	Over-voltage protection (230V, internal built)
BHL	3: 6kA 230/400V	2, 3, 4	C type: 5~ 10In D type: 10~ 15In	1, 2, 3, 4, 5, 6, 10, 16, 20, 25, 32, 40, 50, 63.	Over-voltage protection (230V, internal built)



• Standard: IEC 61009

BHG

- Disconnecter

BHG		2	32		
Type	Rated voltage (V)	Poles (P)	Rated current In (A)	Standard	Mechanical life
BHG	230/400V	1, 2, 3, 4	32A, 40A, 63A, 80A, 100A.	IEC 60947-3	50,000 operations



BHN

- N+L Overload, Short Circuit

BHN	2	1	C	32
Type	Rated breaking capacity (kA) Rated voltage (V)	Poles (P)	Tripping characteristics	Rated current In (A)
BHN	2: 4.5kA; 3: 6kA 230V	1P+N	C type: 5~ 10In	6, 10, 16, 20, 25, 32.



• Standard: IEC 60898

BHK

• Accessories

BHK	2					1	
↓	↓					↓	
Type	Accessory Code					Installation	
	1	2	3	4	5	1	2
BHK	AL	AX	SHT	UVT	OVT	Standard	Option

Note: 1. Standard: Left side mounting of breaker
 2. Option: Left side mounting of other accessory

Type	Auxiliary Contact	Width	Product Code
	AC/12	(mm)	



AL
Alarm Switch

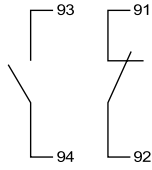

1NO, 1NC
230V 6A
440V 3A

9

BHK11



AX
Auxiliary Contact

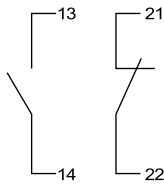

1NO, 1NC
230V 6A
440V 3A

9

BHK21
BHK22

Type	Control Voltage		Auxiliary Contact	Width	Product Code
	V AC	V DC	AC/12	(mm)	



SHT
Shunt Trip

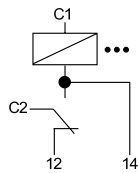

12	12
24-48	12~48
230-415	110-130

1NO, 1NC
230V 6A
440V 3A

18

BHK31
BHK32



UVT
Under Voltage Trip

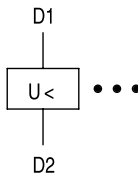

220-240

48

1NO, 1NC
230V 6A
440V 3A

18

BHK41
BHK42

Type	Rated voltage	Current	Over voltage range	Trip time	Width (mm)	Product Code
------	---------------	---------	--------------------	-----------	------------	--------------



OVT
Over Voltage Trip

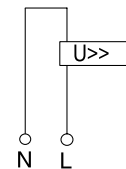

230V

15mA

280V ± 5%

≤ 0.2S

18

BHK51
BHK52

Index

MCCB
ELCB

ATS

ACB

MCB

SPD

MS

MMS

Surge Protective Device | BHP Series



BHP	20	3P	R	320
-----	----	----	---	-----

Type	I _{max} /Limp (kA)	Waveform (μs)	Pole (P)	R	U _c (V)	U _n (V)	U _p (kV)	Waveform (μs)	I _n (kA)	Connection wire diameter	
										L-N	PE
BHP20	20: 20kA	8/20	1P: 1P 1P1: 1P+1 2P: 1P+N 3P: 3P 3P1: 3P+1 4P: 3P+N	With alarm auxiliary contact	320	230/400	≤ 1.3	8/20	10	≧ 2.5mm ²	≧ 6mm ²
BHP40	40: 40kA	8/20			385	230/400	≤ 1.8	8/20	20	≧ 4mm ²	≧ 16mm ²
BHP80	80: 80kA	8/20			385	230/400	≤ 2.1	8/20	40	≧ 10mm ²	≧ 25mm ²
BHP100	100: 100kA	8/20			385	230/400	≤ 2.3	8/20	60	≧ 16mm ²	≧ 25mm ²
BHP250	250: 25kA	10/350			440	230/400	≤ 1.8	10/350	25	≧ 25mm ²	≧ 35mm ²

To enable the surge protective device to work, please read the following note:

1. The grounding system type of the protected device and maximum operating voltage of the power grid U_s. Max.
2. The impulse withstand voltage of the protected device.

Note: 1. BHP20, 40 are plug-in type; BHP80, 100, 250 are fixed type.
2. The standard operation voltage U_c(V) is below table. Max operation voltage U_c(V): 660V.

Normal working conditions

- Frequency: the AC power frequency shall be 50/60Hz.
- Voltage: the voltage continuously supplied between the wiring terminals of the surge protective device shall not exceed its maximum continuous operating voltage U_c.
- Altitude: less than 2,000m.
- Use and storage temperature: -Normal range: -5°C ~ +40°C;
-Ultimate range: -40°C ~ +80°C;
- Humidity: Relative humidity 30%~90% under ambient temperature.

Magnetic Contactor / Switch ◆ AC control



Model		06	09	11	12		
Type	Magnetic Contactor	Nonreversing	S-P06	S-P09	S-P11	S-P12	
		Reversing	S-2×P06	S-2×P09	S-2×P11	S-2×P12	
	Magnetic Switch	without enclosure	Nonreversing	MSO-P06	MSO-P09	MSO-P11	MSO-P12
			Reversing	—	—	MSO-2×P11	MSO-2×P12
		with enclosure	Nonreversing	—	—	MS-P11	MS-P12
			Reversing	—	—	MS-2×P11	MS-2×P12
with enclosure (push button)	Nonreversing	—	—	MS-P11PB	MS-P12PB		
Thermal overload relay	Standard	—	—	TH-P12 E	TH-P12 E		
	With phase failure protection	TH-P09PP	TH-P09PP	TH-P12PP	TH-P12PP		
Rated Capacity	IEC 60947-4-1 EN 60947-4-1 DIN VDE 0660	3 ∅	240V	1.5/ 2/ 6	2.2/ 3/ 9	3.5/ 4.5/ 13	3.5/ 4.5/ 13
			380V	3/ 4/ 6	4/ 5.5/ 9	5.5/ 7.5/ 12	5.5/ 7.5/ 12
			440V	3/ 4/ 6	4/ 5.5/ 9	5.5/ 7.5/ 12	5.5/ 7.5/ 12
			550V	3/ 4/ 6	4/ 5.5/ 9	5.5/ 7.5/ 9	5.5/ 7.5/ 9
			660V	—	—	5.5/ 7.5/ 7	5.5/ 7.5/ 7
	AC 3 (kW/HP/A)	Operation current (Ith) AC1 (A)		20	20	20	20
		Rated impulse voltage (Ui) (V)		AC660	AC660	AC660	AC660
	UL 508 CSA-C22.2	1 ∅	100~120V	0.25/ 5.8	0.5/ 9.8	0.5/ 9.8	0.5/ 9.8
			200~240V	1/ 8	1.5/ 10	2/ 10	2/ 12
		3 ∅	200~240V	2/ 6.8	3/ 9.6	3/ 9.6	3/ 9.6
			380~480V	3/ 4.8	5/ 7.6	7.5/ 11	7.5/ 11
			550~600V	3/ 3.9	5/ 6.1	10/ 11	10/ 11
		Operation current (Ith) AC1 (A)		20	20	24	24
	Rated impulse voltage (Ui) (V)		AC660	AC660	AC600	AC600	
NEMA		00	00	0	0		
Auxiliary Contact	IEC 60947-5-1 EN 60947-5-1 GB14048.4	Contact	Standard	1NO	1NO	1NO	1NO 1NC
			Special	1NC	1NC	1NC	2NC or 2NO
			220V	3.3	3.3	1.6	1.6
			380V	1.9	1.9	0.95	0.95
	Operation current (Ith) AC1 (A)		10	10	16	16	
Contact class (UL)		A600	A600	A600, P600, Q300	A600, P600, Q300		
Mechanical Life AC3 (10 thousand)		120	120	120	120		
Electrical Life (10 thousand)		600	600	600	600		
Magnetic Contactor	Weight (kg)		0.15	0.15	0.33	0.35	
	Installation Dimensions (L×W×H) (mm)		58×46×51	58×46×51	81×43×83.5	81×53×83.5	
	Dimensions (mm)						
Mechanical Interlock		—	—	MPU-11	MPU-21		

Index

MCCB
ELCB

ATS

ACB

MCB

SPD

MS

MMS

Magnetic Contactor / Switch ◆ AC control



Model		15	16	21 (A)	25		
Type	Magnetic Contactor	Nonreversing	S-P15	S-P16	S-P21 (A)	S-P25	
		Reversing	S-2×P15	S-2×P16	S-2×P21 (A)	S-2×P25	
	Magnetic Switch	without enclosure	Nonreversing	MSO-P15	MSO-P16	MSO-P21 (A)	MSO-P25
			Reversing	MSO-2×P15	MSO-2×P16	MSO-2×P21 (A)	MSO-2×P25
		with enclosure	Nonreversing	MS-P15	MS-P16	MS-P21 (A)	MS-P25
			Reversing	MS-2×P15	MS-2×P16	MS-2×P21 (A)	MS-2×P25
		with enclosure (push button)	Nonreversing	MS-P15PB	MS-P16PB	MS-P21PB (A)	MS-P25PB
		Thermal overload relay	Standard	TH-P12 E	TH-P20 E	TH-P20 E	TH-P20 E(TA)
	With phase failure protection		TH-P12PP	TH-P20PP	TH-P20PP	TH-P20(TA)PP	
	Rated Capacity	IEC 60947-4-1 EN 60947-4-1 DIN VDE 0660	3 Ø	240V	4.5/ 6/ 18	4.5/ 6/ 18	5.5/ 7.5/ 24
380V				7.5/ 10/ 16	7.5/ 10/ 18	11/ 15/ 21	12/ 16/ 23
440V				7.5/ 10/ 16	7.5/ 10/ 16	11/ 15/ 21	12/ 16/ 23
550V				7.5/ 10/ 13	7.5/ 10/ 13	11/ 15/ 17	12/ 16/ 20
660V				7.5/ 10/ 9	7.5/ 10/ 9	11/ 15/ 14	12/ 16/ 16
AC 3 (kW/HP/A)		Operation current (Ith) AC1 (A)		25	30	32	32
		Rated impulse voltage (Ui) (V)		AC660	AC660	AC660	AC660
UL 508 CSA-C22.2 AC3 (HP/A)		1 Ø	100~120V	—	1/ 16	2/ 24	2/ 24
			200~240V	—	3/ 17	3/ 17	3/ 17
		3 Ø	200~240V	—	5/ 15.2	7.5/ 22	10/ 28
			380~480V	—	10/ 14	15/ 21	15/ 21
			550~600V	—	10/ 11	15/ 17	15/ 17
		Operation current (Ith) AC1 (A)		—	30	35	40
		Rated impulse voltage (Ui) (V)		—	AC600	AC600	AC600
NEMA		0	0	1	1		
Auxiliary Contact	IEC 60947-5-1 EN 60947-5-1 GB14048.4 AC 15	Contact	Standard	1NO	1NO 1NC	1NO 1NC (2NO 2NC)	1NO 1NC
			Special	1NC	—	—	—
		220V	1.6	1.6	1.6	1.6	
		380V	0.95	0.95	0.95	0.95	
	Operation current (Ith) AC1 (A)		16	16	16	16	
	Contact class (UL)		—	A600, Q300	A600, Q300	A600, Q300	
Mechanical Life AC3 (10 thousand)		120	120	120	120		
Electrical Life (10 thousand)		600	600	600	600		
Magnetic Contactor	Weight (kg)		0.33	0.37	0.38	0.38	
	Installation Dimensions (L×W×H) (mm)		81×43×83.5	81×53.5×83.5	81×53.5×83.5	81×53.5×83.5	
	Dimensions (mm)						
Mechanical Interlock		MPU-11	MPU-21	MPU-21	MPU-21		

Index

MCCB
ELCB

ATS

ACB

MCB

SPD

MS

MMS



30T	35T	40T	50T	60T
S-P30T	S-P35T	S-P40T	S-P50T	S-P60T
S-2×P30T	S-2×P35T	S-2×P40T	S-2×P50T	S-2×P60T
MSO-P30T	MSO-P35T	MSO-P40T	MSO-P50T	MSO-P60T
MSO-2×P30T	MSO-2×P35T	MSO-2×P40T	MSO-2×P50T	MSO-2×P60T
MS-P30T	MS-P35T	MS-P40T	MS-P50T	MS-P60T
MS-2×P30T	MS-2×P35T	MS-2×P40T	MS-2×P50T	MS-2×P60T
MS-P30TPB	MS-P35TPB	MS-P40TPB	MS-P50TPB	MS-P60TPB
TH-P20 E(TA)	TH-P20 E(TA)	TH-P20 E(TA)	TH-P60 E	TH-P60 E(TA)
TH-P20(TA)PP	TH-P20(TA)PP	TH-P20(TA)PP	TH-P60PP	TH-P60(TA)PP
7.5/ 10/ 30	9/ 12.5/ 35	11/ 15/ 44	15/ 20/ 58	19/ 25/ 65
15/ 20/ 28	18.5/ 25/ 30	22/ 30/ 40	30/ 40/ 52	37/ 50/ 65
15/ 20/ 27	18.5/ 25/ 27	22/ 30/ 40	30/ 40/ 52	37/ 50/ 65
15/ 20/ 22	18.5/ 25/ 22	22/ 30/ 32	30/ 40/ 41	37/ 50/ 52
15/ 20/ 18	18.5/ 25/ 18	22/ 30/ 26	30/ 40/ 34	37/ 50/ 43
50	50	50	80	90
AC660	AC660	AC660	AC660	AC660
—	2/ 24	3/ 34	5/ 56	5/ 56
—	5/ 28	7.5/ 40	10/ 50	10/ 50
—	10/ 28	15/ 42	20/ 54	20/ 54
—	20/ 27	20/ 27	30/ 40	40/ 52
—	30/ 32	30/ 32	40/ 41	50/ 52
—	50	50	80	90
—	AC600	AC600	AC600	AC600
1	2	2	2	2
2NO 2NC	2NO 2NC	2NO 2NC	2NO 2NC	2NO 2NC
—	—	—	—	—
1.6	1.6	1.6	1.6	1.6
0.95	0.95	0.95	0.95	0.95
16	16	16	16	16
—	A600, Q300	A600, Q300	A600, Q300	A600, Q300
120	120	120	120	120
600	600	600	600	600
0.38	0.55	0.55	1.05	1.05
81×53.5×83.5	95×73×93	95×73×93	115×87.9×107	115×87.9×107

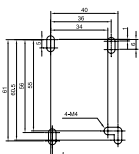

MPU-11

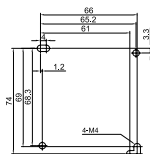

MPU-11

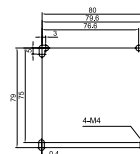

MPU-11

MPU-11

Index

MCCB
ELCB

ATS

ACB

MCB

SPD

MS

MMS

Magnetic Contactor / Switch ◆ AC control

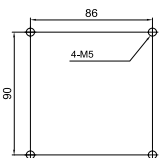
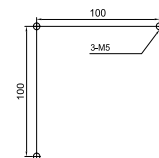
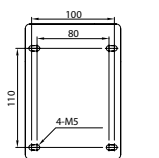
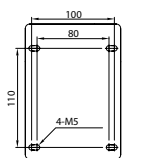

Model		80T	100T	125T	150T		
Type	Magnetic Contactor	Nonreversing	S-P80T	S-P100T	S-P125T	S-P150T	
		Reversing	S-2×P80T	S-2×P100T	S-2×P125T	S-2×P150T	
	Magnetic Switch	without enclosure	Nonreversing	MSO-P80T	MSO-P100T	MSO-P125T	MSO-P150T
			Reversing	MSO-2×P80T	MSO-2×P100T	MSO-2×P125T	MSO-2×P150T
		with enclosure	Nonreversing	MS-P80T	MS-P100T	MS-P125T	MS-P150T
			Reversing	MS-2×P80T	MS-2×P100T	MS-2×P125T	MS-2×P150T
with enclosure (push button)	Nonreversing	—	—	—	—		
Thermal overload relay	Standard	TH-P60 E(TA)	TH-P120 E(TA)	TH-P120 E(TA)	TH-P120 E(TA)		
		With phase failure protection	TH-P60(TA)PP	TH-P120(TA)PP	TH-P120(TA)PP	TH-P120(TA)PP	
Rated Capacity	IEC 60947-4-1 EN 60947-4-1 DIN VDE 0660	3 ∅	240V	22/ 30/ 80	30/ 40/ 105	37/ 50/ 135	45/ 60/ 165
			380V	45/ 60/ 80	60/ 80/ 105	75/ 100/ 130	90/ 125/ 160
			440V	45/ 60/ 75	60/ 80/ 105	75/ 100/ 130	90/ 125/ 160
			550V	45/ 60/ 60	60/ 80/ 85	75/ 100/ 105	90/ 125/ 130
			660V	45/ 60/ 50	60/ 80/ 70	75/ 100/ 90	90/ 125/ 110
	AC 3 (kW/HP/A)	Operation current (Ith) AC1 (A)		100	135	170	200
		Rated impulse voltage (Ui) (V)		AC660	AC660	AC660	AC660
	UL 508 CSA-C22.2 AC3 (HP/A)	1 ∅	100~120V	7.5/ 80	—	—	—
			200~240V	15/ 68	—	—	—
		3 ∅	200~240V	25/ 68	30/ 80	50/ 130	60/ 154
			380~480V	50/ 65	60/ 77	100/ 124	125/ 156
			550~600V	60/ 62	60/ 62	100/ 99	125/ 125
		Operation current (Ith) AC1 (A)		90	100	170	200
	Rated impulse voltage (Ui) (V)		AC600	AC600	AC600	AC600	
NEMA		3	3	3	3		
Auxiliary Contact	IEC 60947-5-1 EN 60947-5-1 GB14048.4 AC 15	Contact	Standard	2NO 2NC	2NO 2NC	2NO 2NC	2NO 2NC
			Special	—	—	—	—
			220V	1.6	1.6	3.3	3.3
			380V	0.95	0.95	1.6	1.6
	Operation current (Ith) AC1 (A)		16	16	16	16	
Contact class (UL)		A600, Q300	A600, Q300	A600, Q300	A600, Q300		
Mechanical Life AC3 (10 thousand)		120	120	120	120		
Electrical Life (10 thousand)		600	600	600	600		
Magnetic Contactor	Weight (kg)		1.5	2.35	2.7	2.7	
	Installation Dimensions (L×W×H) (mm)		142×93×116	116×120×128	152.5×106×140	152.5×106×140	
	Dimensions (mm)						
Mechanical Interlock		MPU-50	Assembled and adjusted by the factory.	MPU-125	MPU-125		



200T	220T	300T	400T	600C
S-P200T	S-P220T	S-P300T	S-P400T	M-600C
S-2×P200T	S-2×P220T	S-2×P300T	S-2×P400T	RC-600C
MSO-P200T	MSO-P220T	MSO-P300T	MSO-P400T	—
MSO-2×P200T	MSO-2×P220T	MSO-2×P300T	MSO-2×P400T	—
MS-P200T	MS-P220T	—	—	—
MS-2×P200T	MS-2×P220T	—	—	—
—	—	—	—	—
TH-P220T E	TH-P220T E	TH-P400T E	TH-P400T E	TH-P600 E
TH-P220TPP	TH-P220TPP	TH-P400TPP	TH-P400TPP	TH-P600PP
55/ 75/ 200	65/ 85/ 220	90/ 125/ 300	110/ 150/ 400	160/ 220/ 620
110/ 150/ 190	120/ 160/ 220	160/ 220/ 300	220/ 300/ 400	315/ 420/ 620
110/ 150/ 190	120/ 160/ 190	185/ 250/ 300	250/ 340/ 400	315/ 420/ 600
110/ 150/ 150	132/ 180/ 180	185/ 250/ 263	250/ 340/ 360	315/ 420/ 500
110/ 150/ 125	132/ 180/ 150	200/ 300/ 220	280/ 380/ 280	—
240	260	350	450	660
AC660	AC660	AC1000	AC1000	AC660
—	—	—	—	—
—	—	—	—	—
75/ 192	75/ 192	100/ 248	125/ 312	—
150/ 180	150/ 180	200/ 240	250/ 302	—
150/ 144	150/ 144	200/ 192	300/ 289	—
240	260	350	450	—
AC600	AC600	AC1000	AC1000	—
4	4	5	5	6
2NO 2NC	2NO 2NC	2NO 2NC	2NO 2NC	2NO 2NC
—	—	—	—	—
3.3	3.3	3.3	3.3	1.6
1.6	1.6	1.6	1.6	0.95
16	16	10	10	16
A600, Q300	A600, Q300	A600, Q300	A600, Q300	A600, Q300
120	120	120	120	60
600	600	600	600	600
4.35	4.35	9.75	9.75	28
185×138×159.5	185×138×159.5	246×164×196.5	246×164×196.5	320×360×234

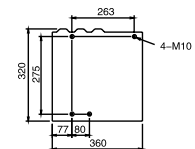
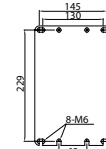
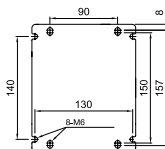

MPU-125	MPU-125	MPU-125	MPU-125	—
---------	---------	---------	---------	---

Index

MCCB
ELCB

ATS

ACB

MCB

SPD

MS

MMS

Magnetic Contactor / Switch ◆ DC control



Type	Magnetic Contactor		SD-P11	SD-P16	SD-P21	
		Nonreversing		SD-P11	SD-P16	SD-P21
	Reversing		SD-2×P11	SD-2×P16	SD-2×P21	
Magnetic Switch	without enclosure	Nonreversing	MDO-P11	MDO-P16	MDO-P21	
		Reversing	MDO-2×P11	MDO-2×P16	MDO-2×P21	
	with enclosure	Nonreversing	—	—	—	
		Reversing	—	—	—	
	with enclosure (push button)	Nonreversing	—	—	—	
	Thermal overload relay	Standard	TH-P12	TH-P20	TH-P20	
With phase failure protection		TH-P12PP	TH-P20PP	TH-P20PP		
Rated Capacity	IEC 60947-4-1 EN 60947-4-1 DIN VDE 0660 AC 3 (kW/HP/A)	3 ∅	240V	3.5/ 4.5/ 13	4.5/ 6/ 18	5.5/ 7.5/ 24
			380/440V	5.5/ 7.5/ 12	7.5/ 10/ 18	11/ 15/ 21
			550V	5.5/ 7.5/ 9	7.5/ 10/ 13	11/ 15/ 17
			660V	5.5/ 7.5/ 7	7.5/ 10/ 9	11/ 15/ 14
	Operation current (lth) AC1 (A)		20	30	32	
	UL 508 CSA-C22.2 AC3 (HP/A)	1 ∅	110~120V	0.5/ 9.8	1/ 16	2/ 24
			220~240V	2/ 12	3/ 17	3/ 17
		3 ∅	220~240V	3/ 9.6	5/ 15.2	7.5/ 22
			440~480V	7.5/ 11	10/ 14	15/ 21
			550~600V	10/ 11	10/ 11	15/ 17
		Operation current (lth) AC1 (A)		24	30	35
	NEMA		0	0	1	
Auxiliary contact		1NO or 1NC	1NO 1NC	1NO 1NC		
Control coil voltage DC (V)		12/ 24/ 48/ 72/ 110/ 125/ 220				
Mechanical Life	AC3 (10 thousand)	120	120	120		
Electrical Life	(10 thousand)	600	600	600		
Magnetic Contactor	Weight (kg)	0.33	0.37	0.38		
	Installation Dimensions (L×W×H) (mm)	81×43×83.5	81×53.5×83.5	81×53.5×83.5		
Dimensions (mm)						
Mechanical Interlock		MPU-11	MPU-11	MPU-11		

Capacitor Contactors

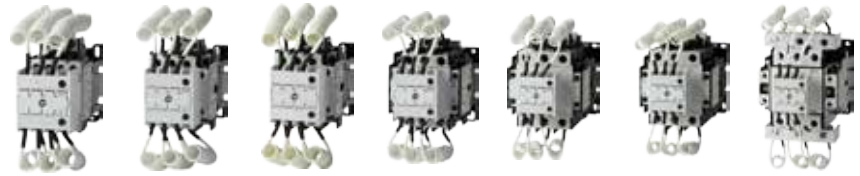

Type		SC-P12	SC-P16	SC-P20	SC-P25	SC-P33	SC-P45	SC-P60		
Rated impulse voltage (Ui)		(V)								
		690	690	690	690	690	690	690		
Rated Capacity	IEC 60947-4-1 EN 60947-4-1 DIN VDE 0660	AC-6b 3 φ (kVar/A)	200~240V	6.7/ 18	8.5/ 22	10/ 26	15/ 39	20/ 48	25/ 66	35/ 92
			400~440V	12.5/ 16	16.7/ 22	20/ 26	25/ 33	33.3/ 44	45/ 59	60/ 86
			660~690V	18/ 15	24/ 20	30/ 25	36/ 30	48/ 40	58/ 49	75/ 63
	AC 3 (kW/HP/A)	Operation current (Ith)	AC1 (A)	20	30	40	50	80	90	100
Auxiliary Contact		2NO or 1NO 1NC	2NO 1NC	2NO 1NC	3NO 2NC	3NO 2NC	3NO 2NC	3NO 2NC		
Auxiliary Contact	IEC 60947-5-1 EN 60947-5-1	AC12 (A)	100~120V	6	6	6	6	6	6	
			200~220V	5	5	5	5	5	5	
			380~440V	3	3	3	3	3	3	
			550~600V	3	3	3	3	3	3	
Operation current (Ith)		(A)	16	16	16	16	16	16	16	
Mechanical Life / Electrical Life (AC-6b)		(10 thousand)	500 / 30	500 / 30	500 / 30	500 / 30	500 / 30	500 / 30	500 / 30	
On/ Off Frequency		(time/ hour)	240	240	240	240	240	240	240	
Magnetic Contactor	Weight		(kg)	0.43	0.48	0.48	0.64	1.15	1.15	1.6
	Installation Dimensions (L×W×H)		(mm)	125×43×112	130×53.5×112	130×53.5×112	143×60×121	164×88×135.5	164×88×135.5	180×100×144
	Dimensions		(mm)							

Star-delta Starter



Model		21	35	50	60	80	100	125	150	220
Type	Without enclosure (no CT)	SDO-P21	SDO-P35	SDO-P50	SDO-P60	SDO-P80	SDO-P100	SDO-P125	SDO-P150	SDO-P220
	Without enclosure (with CT)	SDO-P21T	SDO-P35T	SDO-P50T	SDO-P60T	SDO-P80T	SDO-P100T	SDO-P125T	SDO-P150T	SDO-P220T
	With enclosure (no CT)	SDE-P21	SDE-P35	SDE-P50	SDE-P60	SDE-P80	SDE-P100	SDE-P125	SDE-P150	SDE-P220
	With enclosure (with CT)	SDA-P21	SDA-P35	SDA-P50	SDA-P60	SDA-P80	SDA-P100	SDA-P125	SDA-P150	SDA-P220
Rated Capacity (kW/HP)	200V~220V	11/ 15	19/ 25	22/ 30	30/ 40	37/ 50	45/ 60	55/ 75	75/ 100	110/ 150
	380V~440V	19/ 25	30/ 40	45/ 60	55/ 75	75/ 100	90/ 125	110/ 150	132/ 180	200/ 260
AC Magnetic Contactor	MCM	S-P21	S-P35T	S-P50T	S-P60T	S-P80T	S-P100T	S-P125T	S-P150T	S-P220T
	MCD	S-P21	S-P35T	S-P50T	S-P60T	S-P80T	S-P100T	S-P125T	S-P150T	S-P220T
	MCS	S-P11	S-P16	S-P21	S-P21	S-P35T	S-P35T	S-P50T	S-P50T	S-P60T
Thermal Overload Relay		TH-P20	TH-P60	TH-P60	TH-P120	TH-P120	TH-P120	TH-P220T	TH-P220T	TH-P400T
		TH-P20TA	TH-P60TA	TH-P60TA	TH-P120TA	TH-P120TA	TH-P120TA	TH-P220T	TH-P400T	TH-P400T
Conducting wire size of motor (mm ²)	Power supply side	2.5~16	2.5~25	2.5~35	2.5~50	10~70	10~95	35~150	35~150	35~240
	Load side	2.5~10	2.5~16	2.5~25	2.5~35	4~50	4~70	10~95	10~90	16~150
	Control loop	1~2.5	1~2.5	1~2.5	1~2.5	1~2.5	1~2.5	1~2.5	1~2.5	1~2.5

Index

MCCB
ELCB

ATS

ACB



MCB

SPD

MS

MMS

Push Button | PB Series

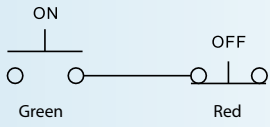
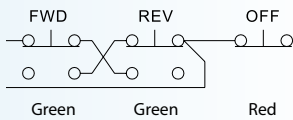
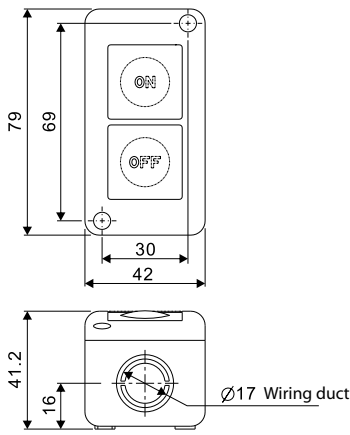
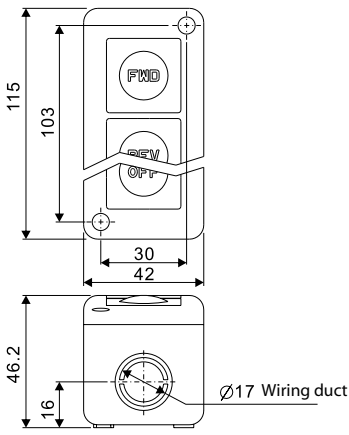
Type	PB2	PB3
		
Contact schema		
External dimensions (mm)		
WET.	72.5g	110g

Separate Mounting Unit



Type	UATP12
TOR	TH-P12

Magnetic Control Relays



Type		SR-P40	SR-P50	SR-P80
Auxiliary Contact		4NO 3NO 1NC 2NO 2NC	5NO 4NO 1NC 3NO 2NC 2NO 3NC	8NO 7NO 1NC 6NO 2NC 5NO 3NC 4NO 4NC
Rated Capacity IEC 60947-4-1 AC15 (A)	220V	1.6	1.6	1.6
	380V	0.95	0.95	0.95
Rated impulse voltage	(Ui) (V)	660	660	660
Operation current	(Ith) (A)	16	16	16
Contact Class	(UL)	A600, Q300	A600, Q300	A600, Q300
Electrical Life	(10 thousand)	50 and up	50 and up	50 and up
Mechanical Life	(10 thousand)	500	500	500
On/ Off Frequency	(time per / hour)	500	500	500

Definite Purpose Magnetic Contactor | SF Series

Type		20	25	30	35	40
Type		 C1	 C2	 C3		
Type	1 Pole	SF20C1	SF25C1	SF30C1	SF35C1	SF40C1
	2 Pole	SF20C2	SF25C2	SF30C2	SF35C2	SF40C2
	1Pole w/shunt	SF20C3	SF25C3	SF30C3	SF35C3	SF40C3
Start Current(A) (Per Pole)	AC 240V / AC 277V	120	150	180	180	180
	AC 480V	100	125	150	150	150
	AC 600V	80	100	120	120	120
Start Current(A) (Single Phase) (2 Pole)	AC 240V / AC 277V	120	150	180	210	240
	AC 480V	100	125	150	175	200
	AC 600V	80	100	120	140	160
Rated Current w/resistance load (A)		30	35	40	50	50
Full Rated Current (A)		20	25	30	35	40
Mechanical / Electrical life (10 thousand)		50/25	50/25	50/25	50/25	50/25
Operation frequency (time / hour)		360	360	360	360	360
Coil Control Voltage 50/60 Hz		24 / 110-120 / 200 / 220 / 208-240 / 277				

Index

MCCB
ELCB

ATS

ACB

MCB

SPD

MS

MMS

Auxiliary Contact Block

◆ AP Series



Installation		2P FRONT MOUNTED TYPE			4P FRONT MOUNTED TYPE			SIDE MOUNTED TYPE		
Type		AP-20	AP-11	AP-02	AP-40	AP-31	AP-22	APS-11	APL-11	
Contact		2NO	1NO 1NC	2NC	4NO	3NO 1NC	2NO 2NC	1NO 1NC	1NO 1NC	
Applicable contactor		SR-P40, SR-P50 S-P11~S-P80T SD-P11~SD-P21			SR-P40, SR-P50 S-P11~S-P80T SD-P11~SD-P21			SR-P40, SR-P50 S-P11~S-P60T SD-P11~SD-P21		
Rated Capacity AC 15 (A)	220V								1.6	
	380V								0.95	
Operation current (Ith) (A)									16	

Index

Auxiliary Contact Block

◆ MAP Series

Installation		2P FRONT MOUNTED TYPE			4P FRONT MOUNTED TYPE			
Type		MAP-20	MAP-11	MAP-02	MAP-40	MAP-31	MAP-22	
Contact		2NO	1NO 1NC	2NC	4NO	3NO 1NC	2NO 2NC	
Applicable contactor		S-P06, S-P09.						
Rated Capacity AC 15 (A)	220V						3.3	
	380V						1.9	
Operation current (Ith) (A)							10	

MCCB
ELCB

ATS

ACB

MCB

Timer



Type		PTR-30		PTR-180		
Contact		1NO 1NC		1NO 1NC		
Applicable contactor		SR-P40, SR-P50, S-P11~S-P60T, SD-P11~SD-P21.				
Rated Capacity AC 15 (A)	220V					1.6
	380V					0.95
Operation current (Ith) (A)						16

SPD

MS

MMS



Varistors: Anti-surge interference

Type		BMSACW220V		BMSACW380V	
Applicable contactor		SR-P40, SR-P50, S-P11~S-P60T.			

Characteristics

Type		S-P06 S-P09	S-P11 S-P15	S-P12	S-P16 S-P21 S-P25 S-P30T	S-P35T S-P40T	S-P50T S-P60T S-P80T	S-P100T	S-P125T S-P150T	S-P200T S-P220T	S-P300T S-P400T	M-600C
Characteristics												
Coil Capacity (VA)	Impulse	25	55	55	55	72	250	319	370	440	700	4840
	Operation	5	11	11	11	12	28	36	42	50	50	242
Power Consumption (W)		1.6	2.5	2.5	2.5	3	7	11	10	12	7	80
Operation Vol. (Ue)	On	55~70%	55~68%	55~68%	59~70%	60~75%	63~75%	65~75%	75~80%	75~80%	65~80%	72~79%
	Off	35~50%	34~48%	34~48%	36~52%	40~57%	40~57%	40~55%	40~55%	40~60%	20~50%	59~66%
Close Time (ms)	Aux. OFF	5-12	5-12	4-11	6-14	6-13	6-13	18-28	9-20	10-19	22-37	42-71
	Aux. ON	6-15	10-18	10-18	10-18	12-20	12-20	22-32	15-24	17-25	25-40	49-78
	Contact ON	6-15	10-18	10-18	10-18	12-20	12-20	22-32	10-20	12-27	30-45	51-80
Open Time (ms)	Aux. OFF	6-15	12-20	9-18	9-19	10-17	10-17	50-100	9-18	10-20	40-60	61-97
	Aux. ON	5-12	8-15	4-13	6-14	5-12	5-12	48-98	7-15	7-18	31-51	58-94
	Contact ON	5-12	8-15	4-13	6-14	5-12	5-12	46-96	7-15	7-20	30-50	57-93

Coil Specifications Table

◆ S-P06~S-P25, S-P30T~P220T, SR-P40~P50, SC-P12~P60						
Description	AC12V	AC24V	AC48V	AC110V	AC120V	AC220V
Coil rated specifications marking	12V 50Hz 12V 60Hz	24V 50Hz 24V 60Hz	48~50V 50Hz 48~50V 60Hz	100V 50Hz 100~110V 60Hz	110~120V 50Hz 115~120V 60Hz	200~220V 50Hz 220V 60Hz
Description	AC240V	AC380V	AC440V	AC480V	AC550V	
Coil rated specifications marking	220~240V 50Hz 240~260V 60Hz	346~380V 50Hz 380V 60Hz	400V 50Hz 400~440V 60Hz	415~440V 50Hz 460~480V 60Hz	500V 50Hz 500~550V 60Hz	
◆ S-P300T~P400T						
Description	AC48V	AC220V	AC380V	AC550V		
Coil rated specifications marking	AC 48~50V 50/60Hz DC 48V	AC 100~240V 50/60Hz DC 100~220V	AC 265~450V 50/60Hz	AC 440~575V 50/60Hz		
◆ M-600C						
Description	AC110V	AC120V	AC220V	AC260V		
Coil rated specifications marking	100V 50Hz 100~110V 60Hz	110~120V 50Hz 115~120V 60Hz	208~220V 50Hz 220V 60Hz	240~260V 50Hz 260~280V 60Hz		
Description	AC380V	AC440V	AC480V	AC550V		
Coil rated specifications marking	346~380V 50Hz 380V 60Hz	380~415V 50Hz 400~440V 60Hz	415~440V 50Hz 460~480V 60Hz	500V 50Hz 500~550V 60Hz		

Index

MCCB
ELCB

ATS

ACB

MCB

SPD

MS

MMS

Selection Table ◆ Direct On-Line Starter

Motor rated capacity kW (HP)		3 φ 380V~440V		Selection of the contactor							
		Heating element rating (A)									
0.025	(1/30)	0.13A	0.1~0.16A	S-P06	S-P09						
0.04	(1/19)	0.2A	0.16~0.24A								
0.09	(1/8)	0.32A	0.24~0.4A								
0.18	(1/4)	0.5A	0.4~0.6A								
0.25	(1/3)	0.8A	0.6~1.0A								
0.37	(1/2)	1.3A	1.0~1.6A								
0.55	(3/4)	2.0A	1.6~2.4A								
0.75	(1)										
1.1	(1 1/2)	3.2A	2.4~4.0A								
1.5	(2)										
2.2	(3)	5A	4.0~6.0A								
3	(4)	7.5A	6.0~9.0A								
0.05	(1/15)	0.25A	0.19~0.31A	S-P11, S-P12	S-P15, S-P16						
0.1	(1/8)	0.4A	0.3~0.5A								
0.2	(1/4)	0.6A	0.45~0.75A								
0.3	(2/5)	0.9A	0.7~1.1A								
0.4	(1/2)	1.2A	0.9~1.5A								
0.75	(1)	1.7A	1.3~2.1A								
1.1	(1 1/2)	2.1A	1.6~2.6A								
1.5	(2)	3.3A	2.5~4.1A								
2.2	(3)	4.4A	3.4~5.4A								
3	(4)	6.5A	5~8A								
3.7	(5)			S-P21	S-P25						
4	(5 1/2)	9A	7~11A								
4.5	(6)					S-P30T	S-P35T				
5.5	(7 1/2)	11A	9~13A								
7.5	(10)	15A	12~18A								
11	(15)	21A	17~24A								
12	(16)							S-P40T	S-P50T		
15	(20)	28A	22~34A								
19	(25)	33A	28~38A								
22	(30)									S-P60T	S-P80T
25	(35)	40A	32~48A								
30	(40)	54A	43~65A								
37	(50)			S-P100T	S-P125T						
45	(60)	67A	54~80A								
50	(70)	80A	60~100A								
60	(80)					S-P150T	S-P200T				
75	(100)	105A	80~130A								
90	(125)	130A	100~160A								
110	(150)							S-P220T	S-P300T		
132	(180)	200A	150~250A								
150	(200)									S-P400T	M-600C
160	(220)	260A	200~320A								
160	(220)										
220	(330)	350A	260~440A								
250	(350)										
250	(350)										
315	(420)	500A	400~600A								

Magnetic Switch

- Index
- MCCB
ELCB
- ATS
- ACB
- MCB
- SPD
- MS
- MMS

Selection Table ◆ λ - Δ Starter

Heater selection table (A)	Motor output kW (HP)				TH selection of λ - Δ Starter																	
	A		B		21		35		50		60		80		100		125		150		220	
	200~220V		380~440V		A	B	A	B	A	B	A	B	A	B	A	B	A	B	A	B	A	B
6.5	1.5	(2)	3	(4)	TH-P20	TH-P20																
9	1.9	(2 1/2)	3.7	(5)																		
9	2.2	(3)	4.5	(6)																		
11	3	(4)	5.5	(7 1/2)																		
15	3.7	(5)	7.5	(10)																		
15	4.5	(6)	10	(13)																		
21	5.5	(7 1/2)	11	(15)	TH-P20TA	TH-P20TA																
28	6.5	(8)	14	(19)																		
28	7.5	(10)	15	(20)																		
33	9	(12 1/2)	19	(25)	TH-P60	TH-P60	TH-P60	TH-P60	TH-P60	TH-P60	TH-P60	TH-P60	TH-P60	TH-P60	TH-P60	TH-P60	TH-P60	TH-P60	TH-P60	TH-P60	TH-P60	TH-P60
40	11	(15)	22	(30)																		
40	14	(19)	26	(35)																		
54	15	(20)	30	(40)	TH-P120	TH-P120	TH-P120	TH-P120	TH-P120	TH-P120	TH-P120	TH-P120	TH-P120	TH-P120	TH-P120	TH-P120	TH-P120	TH-P120	TH-P120	TH-P120	TH-P120	TH-P120
67	19	(25)	37	(50)																		
80	22	(30)	45	(60)																		
80	25	(34)	50	(67)	TH-P220T	TH-P220T	TH-P220T	TH-P220T	TH-P220T	TH-P220T	TH-P220T	TH-P220T	TH-P220T	TH-P220T	TH-P220T	TH-P220T	TH-P220T	TH-P220T	TH-P220T	TH-P220T	TH-P220T	TH-P220T
105	30	(40)	55	(75)																		
130	37	(50)	75	(100)																		
160	45	(60)	90	(125)	TH-P400T	TH-P400T	TH-P400T	TH-P400T	TH-P400T	TH-P400T	TH-P400T	TH-P400T	TH-P400T	TH-P400T	TH-P400T	TH-P400T	TH-P400T	TH-P400T	TH-P400T	TH-P400T	TH-P400T	TH-P400T
200	55	(75)	110	(150)																		
200	65	(85)	132	(200)																		
260	75	(100)	150	(200)	TH-P400T	TH-P400T	TH-P400T	TH-P400T	TH-P400T	TH-P400T	TH-P400T	TH-P400T	TH-P400T	TH-P400T	TH-P400T	TH-P400T	TH-P400T	TH-P400T	TH-P400T	TH-P400T	TH-P400T	TH-P400T
350	110	(150)	200	(260)																		



- Index
- MCCB
ELCB
- ATS
- ACB
- MCB
- SPD
- MS
- MMS



MANUAL MOTOR STARTER

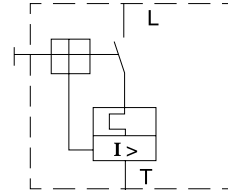
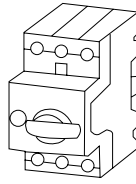

Power factor AC-3 400V (kW)	Rated current In (A)	Overload adjustable range In (A)	Tripping current (A) Id ± 20%	Type	
				Button	Rotary
—	0.16	0.1-0.16	1.92	MR-32S-0.16	MR-32R-0.16
—	0.25	0.16-0.25	3	MR-32S-0.25	MR-32R-0.25
—	0.4	0.25-0.4	4.8	MR-32S-0.4	MR-32R-0.4
—	0.63	0.4-0.63	7.56	MR-32S-0.63	MR-32R-0.63
—	1	0.63-1	12	MR-32S-1	MR-32R-1
0.37	1.6	1-1.6	19.2	MR-32S-1.6	MR-32R-1.6
0.75	2.5	1.6-2.5	30	MR-32S-2.5	MR-32R-2.5
1.5	4	2.5-4	48	MR-32S-4	MR-32R-4
2.2	6.3	4-6.3	75.6	MR-32S-6.3	MR-32R-6.3
4	10	6-10	120	MR-32S-10	MR-32R-10
5.5	14	9-14	168	MR-32S-14	MR-32R-14
7.5	18	13-18	216	MR-32S-18	MR-32R-18
11	23	17-23	276	MR-32S-23	MR-32R-23
11	25	20-25	300	MR-32S-25	MR-32R-25
15	32	24-32	384	MR-32S-32	MR-32R-32

Side AX (MR-AN)

Front AX (MR-AE)

SHT (MR-AS)



AL (MR-AM)

UVT (MR-AU)



MMS





VCB
Vacuum Circuit Breaker

Based in Taiwan

Breaker & Switchgear System

Towards the Development of Globalization



MCB / ELCB
Miniature Circuit Breaker



ACB
Air Circuit Breaker



BHA
Miniature Circuit Breaker



SW1100-P
Pre-Payment
Electricity Meter



BHP
Surge Protective Device



MCCB / ELCB
Molded Case Circuit Breaker /
Earth-Leakage Circuit Breaker



MS
Magnetic Contactor / Switch



SW3005
Multi-function
Electricity Meter



Capacitor
Cylinder/ Box Type



SLPR
3-phase Sequence
Protection Relay



ATS
Automatic Transfer
Switches



SPM8 / SPM3
Digital Multi-Meter



APFR
Auto Power Factor Regulate

SHIHLIN ELECTRIC & ENGINEERING

Air Circuit Breaker, Molded Case Circuit Breaker, Earth-Leakage Circuit Breaker, Electronic Molded Case Circuit Breaker, Miniature Circuit Breaker, Residual Current Circuit Breaker, Automatic Transfer Switches, Magnetic Contactor/ Switch, Surge Protective Device, Low Voltage Power Capacitors, Digital Multi-Meter, Inverter



circuit-breaker.seec.com.tw

Head Office

16F, No.88, Sec.6, Chung-Shan N. Rd., Taipei, Taiwan. 111

T. +886-2-2834-2662 F. +886-2-2836-6187

International Sales Dept.

3F, No.9, Sec.1, Chang-An E. Rd., Taipei, Taiwan. 104

T. +886-2-2541-9822 F. +886-2-2581-2665

e-mail. b.export@seec.com.tw

**KIM QUANG ELECTRIC
DISTRIBUTOR**

www.kimquang.vn

www.kimquang.com.vn

Hotline: 0931 455 668

Distributor

1301, bo01-4, 1,000