

# ELECTRONIC MOLDED CASE CIRCUIT BREAKER



**KIM QUANG ELECTRIC DISTRIBUTOR**

Hotline: 0931 455 668

Sales: 0909 635 266 – 0938 118 428

**SHIHLIN ELECTRIC & ENGINEERING**

## I . Product Description

- Standard: IEC/EN 60947-2 & CE Marked
- Rated current: 40~1250A
- Frequency: 50/60Hz
- Rated insulation voltage  $U_i(V)$ : 690V
- Rated operation voltage  $U_e(V)$ : 400V
- Function :
  - + Long-time delay over-current protection
  - + Short-time delay over-current protection
  - + Short-circuit current protection
- Flexible adjustable: Tripping time, current
- Remote control via communication module

## II. Operation Condition

- Ambient temperature:  $-5^{\circ}C \sim +40^{\circ}C$
- Altitude limit: Below 2,000M
- Humidity: Max. 90% %
- Pollution: Grade 3.
- Installation category (over-voltage category):
  - Category III for the circuit breaker
  - Category II for other auxiliary circuits and control circuits

## III. Catalogue designation

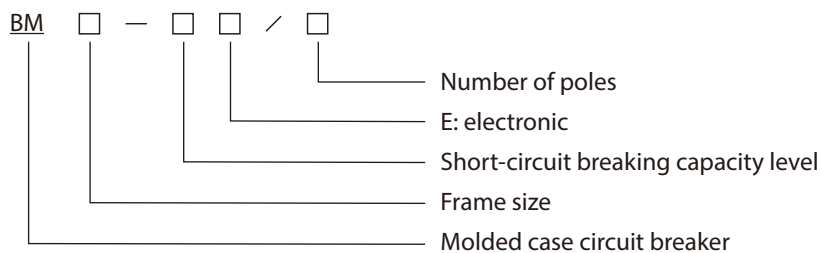

### IV. Selection Instruction

Frame size (Inm)	Level code	Rated ultimate short circuit breaking capacity Icu (kA)						Poles (P)	Rated current In (A)	Overload long-time delay current setting value Ir (A)	Accessories		Option code
		GB14048.2		IEC60947-2							Code	Description	
		230V	440V	220V	380V	440V	500V						
100	HE	85	50	85	50	42	25	100	40, 45, 50, 60, 70, 80, 90, 95, 100	blank	N/A		
	RE	100	70	100	70	55	42						
	UE	125	85	125	85	85	65			AX	Auxiliary switch		
160	HE	85	50	85	50	42	25	160	64, 72, 80, 96, 112, 128, 144, 152, 160	AL	Alarm switch	C: communication function available Blank: N/A	
	RE	100	70	100	70	55	42			SHT	Shunt trip		
	UE	125	85	125	85	85	65			UVT	Under-voltage trip		
250	HE	85	50	85	50	42	25	250	100, 113, 125, 150, 175, 200, 225, 238, 250	COM	Communication module		
	RE	100	70	100	70	55	42			HUB	Communication hub		
	UE	125	85	125	85	85	65						
400	HE	85	50	85	50	42	25	400	160, 180, 200, 240, 280, 320, 360, 380, 400				
	RE	100	70	100	70	55	42						
	UE	125	85	125	85	85	65						
630	HE	85	50	85	50	50	25	630	252, 284, 315, 378, 441, 504, 567, 600, 630				
	RE	100	70	100	70	70	42						
	UE	125	85	125	100	85	65						
800	SE	85	50	85	50	50	25	800	320, 360, 400, 480, 560, 640, 720, 760, 800				
	HE	100	70	100	70	70	42						
	RE	125	85	125	100	85	65						
1000	SE	100	70	100	70	70	50	1000	400, 450, 500, 600, 700, 800, 900, 950, 1000				
	HE	125	85	125	100	85	65						
1250	SE	100	70	100	70	70	50	1250	500, 563, 625, 750, 875, 1000, 1125, 1188, 1250				
	HE	125	85	125	100	85	65						

**Note:**

1. Frame size 100/160/250: UVT not available
2. 1000-SE/HE, 1250-SE/HE UVT & SHT not available
3. Frame size 1000/1250: communication function not available
4. The accessories COM, HUB are not applied to the circuit breaker with no communication function
5. Frame size 100/160/250: When the MCCB quips with communication function, there will be no accessories can be installed, such as AX, UVT, SHT and AL
6. One communication HUB can be applied to Maximum 4 or 5 communication modules

## V. Protection Setting and Characteristics

### 1. Long-time delay over-current protection

Current setting $I_r = 0.4/0.45/0.5/0.6/0.7/0.8/0.9/0.95/1.0 \times I_n$						
Current	Tripping time requirement					
1.05 $I_r$	No tripping within 2hr					
1.3 $I_r$	Tripping within 2hr					
2 $I_r$	Tripping time setting $T_r$ (s)	20	40	60	80	160

- ★ The current value tolerance is  $\pm 10\%$ ; tripping time tolerance is  $\pm 20\%$ .
- ★ Please specify, when place the order of 4P circuit breaker with neutral protection and setting at  $0.5I_r$  or  $1.0I_r$ .
- ★★ This function cannot be "off"

### 2. Short-time delay over-current protection

Current setting $I_s = 2/3/4/5/6/7/8/10 \times I_r$						
Current	Tripping time requirement					
$I_s \leq I \leq 8I_r$	Inverse-time	Inverse time curve				
$I > 8I_r$		Tripping time setting $T_s$ (s)	0.1	0.2	0.3	0.4
$I \geq I_s$	Definite-time	Tripping time setting $T_s$ (s)	0.1	0.2	0.3	0.4

- ★ The current value tolerance is  $\pm 15\%$ ; tripping time tolerance is  $\pm 20\%$  ( $T_s = 0.1 \pm 0.03s$ )
- ★ BM100-E, BM160-E and BM250-E do not provide with the short-time delay over-current protection characteristic.
- ★ This function can be "off"

### 3. Short-circuit current protection (instantaneous characteristic)

Current setting $I_i = 1.5/2/4/6/8/10/11 \times I_n$	
Current	Tripping time requirement
$I \leq 0.80I_i$	No tripping within 0.2s
$I \geq 1.2I_i$	Tripping within 0.2s

- ★ The current value tolerance is  $\pm 15\%$
- ★ This function cannot be "off"

#### IV. Selection Instruction

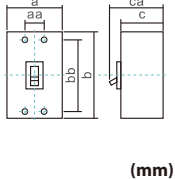
Frame size (AF) (Inm)		100			160			250			
Type		BM100-HE	BM100-RE	BM100-UE	BM160-HE	BM160-RE	BM160-UE	BM250-HE	BM250-RE	BM250-UE	
Rated current In (A) at ambient temp. 40°C		100			160			250			
Adjustable current Ir (A)		40, 45, 50, 60, 70, 80, 90, 95, 100.			64, 72, 80, 96, 112, 128, 144, 152, 160.			100, 113, 125, 150, 175, 200, 225, 238, 250.			
Rated operation voltage Ue (V)		400			400			400			
Rated insulation voltage Ui (V)		690			690			690			
Rated impulse withstand voltage Uimp (kV)		8			8			8			
Number of poles (P)		3P / 4P			3P / 4P			3P / 4P			
Model		HE	RE	UE	HE	RE	UE	HE	RE	UE	
Rated breaking capacity Icu (kA)		50	70	85	50	70	85	50	70	85	
Dimensions (mm)	 <p>(mm)</p>	a	105 / 140			105 / 140			105 / 140		
		b	165			165			165		
		c	86			86			86		
		ca	112			112			112		
		bb	126			126			126		
		aa	35			35			35		
Weight (kg)		2.5 / 3.0			2.5 / 3.0			2.5 / 3.0			
Endurance	Electrical life (10 thousand)	1,000			1,000			1,000			
	Mechanical life (10 thousand)	8,500			7,000			7,000			
Connection		Clamp terminal			Clamp terminal			Clamp terminal			
Trip unit		Electronic			Electronic			Electronic			
Trip button		Equipped			Equipped			Equipped			
Category		A			A			A			
Optional accessories	Alarm switch (AL)	○			○			○			
	Auxiliary switch (AX)	○			○			○			
	Shunt trip (SHT)	○			○			○			
	Under-voltage trip (UVT)	—			—			—			
	Lead wiring terminal (LT)	○			○			○			
	Motor operation device	○			○			○			
	Communication (COM)	○			○			○			
	Communication (HUB)	○			○			○			

400			630			800			1000		1250	
BM400-HE	BM400-RE	BM400-UE	BM630-HE	BM630-RE	BM630-UE	BM800-SE	BM800-HE	BM800-RE	BM1000-SE	BM1000-HE	BM1250-SE	BM1250-HE
400			630			800			1000		1250	
160, 180, 200, 240, 280, 320, 360, 380, 400.			252, 284, 315, 378, 441, 504, 567, 600, 630.			320, 360, 400, 480, 560, 640, 720, 760, 800.			400, 450, 500, 600, 700, 800, 900, 950, 1000.		500, 563, 625, 750, 875, 1000, 1125, 1188, 1250.	
400			400			400			400		400	
690			690			690			690		690	
8			8			8			8		8	
3P / 4P			3P / 4P			3P / 4P			3P		3P	
HE	RE	UE	HE	RE	UE	SE	HE	RE	SE	HE	SE	HE
50	70	85	50	70	85	50	70	85	70	85	70	85
140 / 185			210 / 280			210 / 280			210		210	
257			275			275			406		406	
103			103			103			140		140	
144			155			155			190		190	
194			243			243			375		375	
44			70			70			70		70	
7 / 8			11.5 / 14.5			11.5 / 14.5			26		26	
1,000			1,000			500			500		500	
4,000			4,000			2,500			2,500		2,500	
Busbar			Busbar			Busbar			Busbar		Busbar	
Electronic			Electronic			Electronic			Electronic		Electronic	
Equipped			Equipped			Equipped			Equipped		Equipped	
A			A			A			A		A	
○			○			○			○		○	
○			○			○			○		○	
○			○			○			-		-	
○			○			○			-		-	
-			-			-			-		-	
○			○			○			-		-	
○			○			○			-		-	
○			○			○			-		-	

## VII. Description of Control Panel

### 1. BM100-E, BM160-E and BM250-E

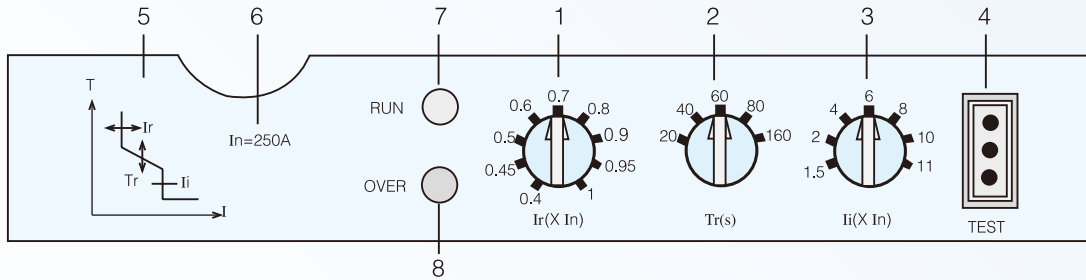

- (1) Overload long-time delay tripping current  $I_r$  setting, 9-steps setting ( $I_r = 0.4/0.45/0.5/0.6/0.7/0.8/0.9/0.95/1.0 * I_n$ ).
- (2) Overload long-time delay tripping time  $T_r$  (2 $I_r$  tripping time), 5-steps setting ( $T_r = 20, 40, 60, 80, 160s$ ).
- (3) Short-circuit instantaneous current  $I_i$  setting, 7-steps setting ( $I_i = 1.5/2/4/6/8/10/11 * I_n$ ).
- (4) Testing port is used for tripping simulation test.
- (5) Electronic trip protection characteristic curve.
- (6) Rated current
- (7) Operation indicator: indicator flashes green during normal operation.
- (8) Overload indicator: indicator flashes red if the current reaches or over 1.05 times of the current.

### 2. BM400-E, BM630-E, BM800-E, BM1000-E and BM1250-E

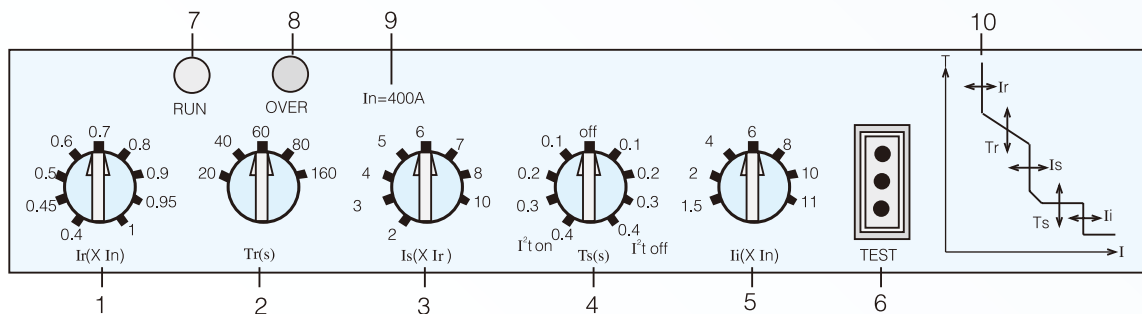

- (1) Overload long-time delay tripping current  $I_r$  setting, 9-steps setting ( $I_r = 0.4/0.45/0.5/0.6/0.7/0.8/0.9/0.95/1.0 * I_n$ ).
- (2) Overload long-time delay tripping time  $T_r$  (2 $I_r$  tripping time), 5-steps setting ( $T_r = 20, 40, 60, 80, 160s$ ).
- (3) Short-circuit short-time delay tripping current  $I_s$  setting, 8-steps setting ( $I_s = 2/3/4/5/6/7/8/10 * I_r$ );
- (4) Short-circuit short-time delay tripping time  $T_s$  setting, 4-steps setting ( $T_s = 0.1/0.2/0.3/0.4s$ );
- (5) Short-circuit instantaneous current  $I_i$  setting, 7-steps setting ( $I_i = 1.5/2/4/6/8/10/11 * I_n$ ).
- (6) Testing port is used for tripping simulation test.
- (7) Operation indicator: indicator flashes green during normal operation.
- (8) Overload indicator: indicator flashes red if the current reaches or over 1.05 times of the current.
- (9) Rated current
- (10) Electronic trip protection characteristic curve.

### VIII. Optional Accessories Installation Table

Model	Poles	AL	AX	SHT or UVT	AL + AX	AL+SHT or UVT	AX+SHT or UVT	AL+AX+SHT or UVT
BM100-HE/RE/UE BM160-HE/RE/UE BM250-HE/RE/UE	3P 4P							No UVT
BM400-HE/RE/UE	3P 4P							
BM630-HE/RE/UE BM800-SE/HE/RE	3P 4P							
BM1000-SE/HE BM1250-SE/HE	3P							

Notes:

1. Standard mounting: AL/AX – left mount; SHT/UVT – right mount
2. SHT equipped coil anti-burning protection switch
3. Accessories of MCCB BM100, BM160 and BM250 (HE/RE/UE) right-side mount is not allowed.
4. The communication function takes 2 mounting space of AL(AX); therefore BM-100-E, 160E and 250E (HE/RE/UE), can only equip either communication or AL(AX)

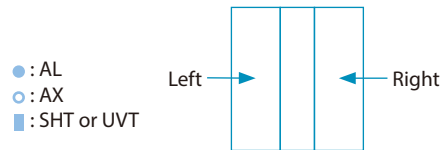



## IX. Trip curve

### 1、BM100-E、BM160-E、BM250-E

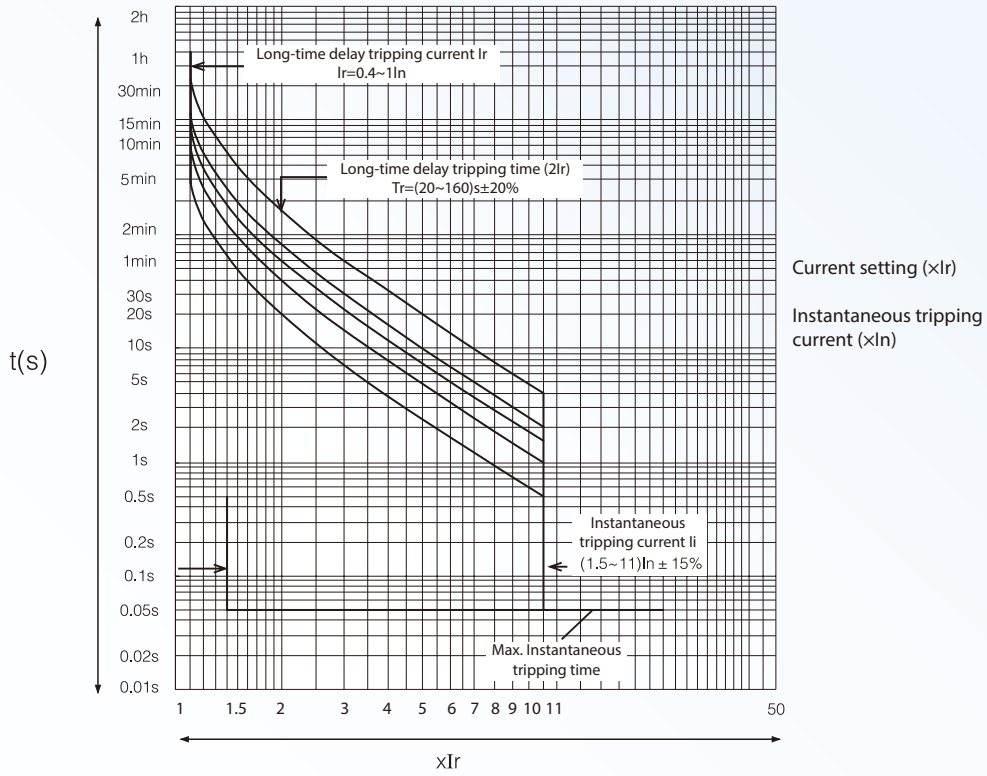

### 2、BM400-E、BM630-E、BM800-E、BM1000-E、BM1250-E

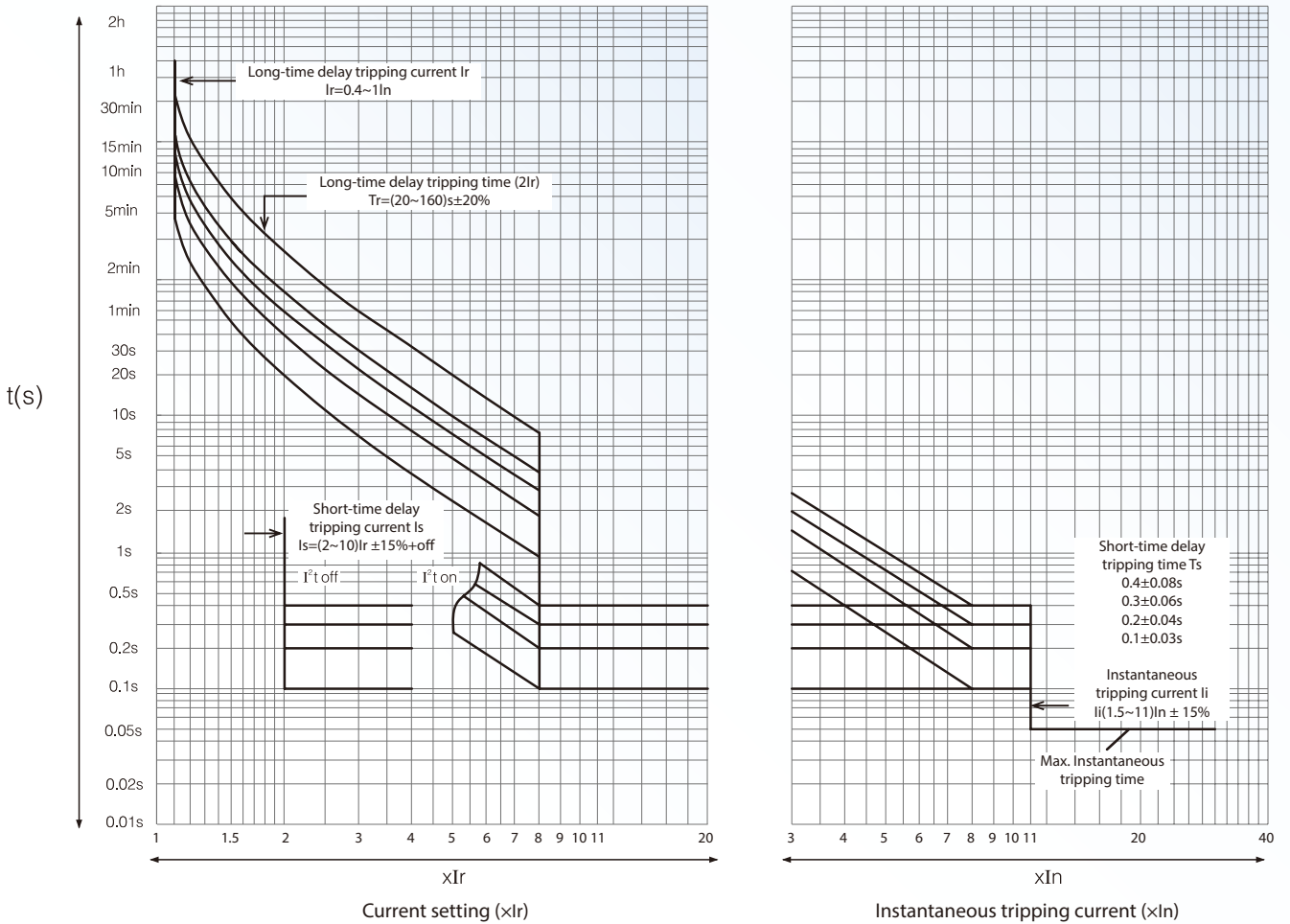

## X. Dimension

### BM100-HE/RE/UE、BM160-HE/RE/UE、BM250-HE/RE/UE

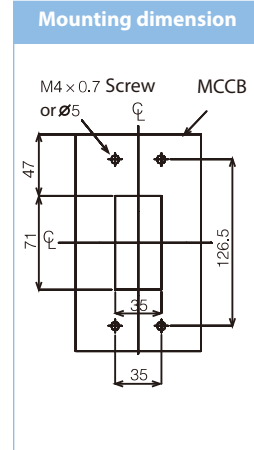
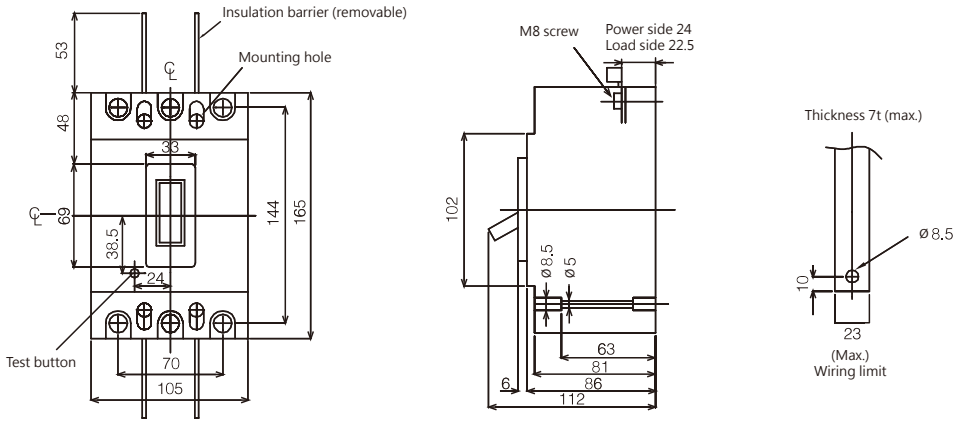

### BM400-HE/RE/UE

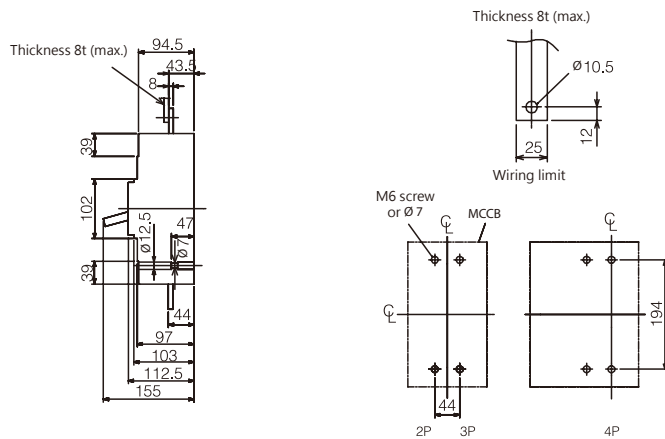
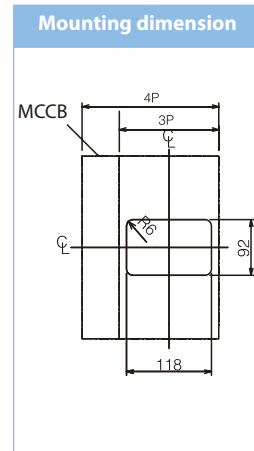
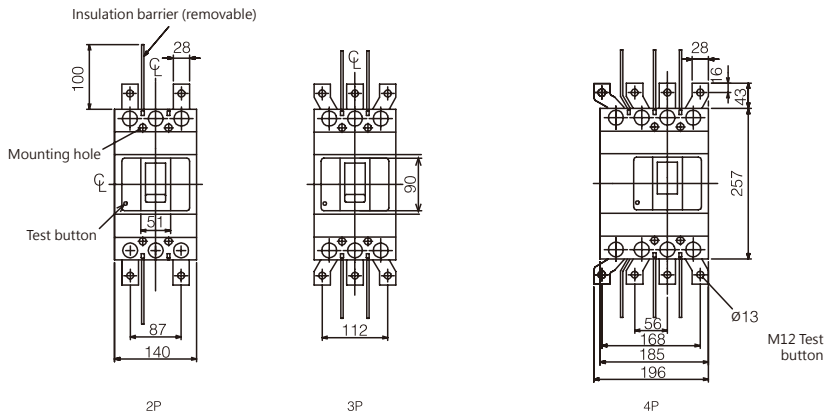

**BM630-HE/RE/UE · BM800-SE/HE/RE**

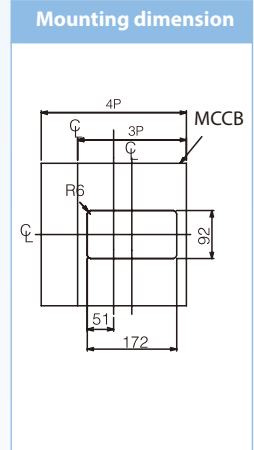
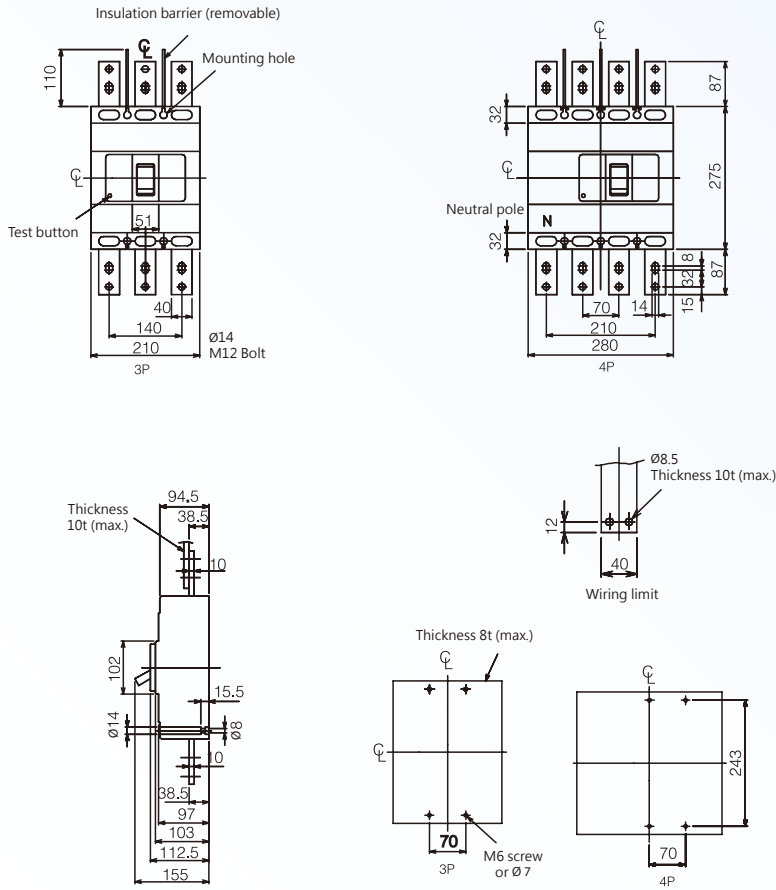

**BM1000-SE/HE · BM1250-SE/HE**

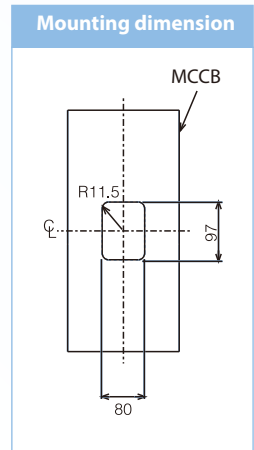
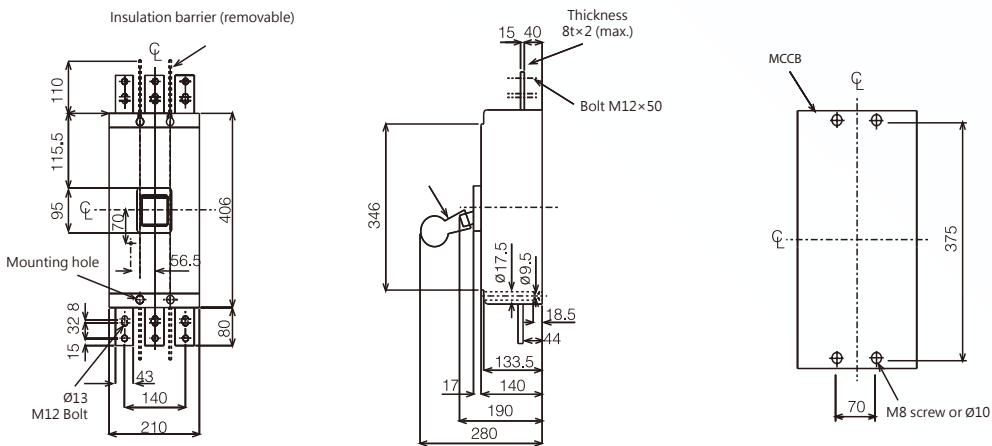

## XI. Communication function



Remote control function is available via PC system if BM-E series with ETU-COM

### Communication function

- Data observe:
  - + Model, series number, Certificate of Original, Production date.
  - + Communication parameter: Potocal, Baud Rate, IP address
  - + Operation condition: ON, OFF, Trip
  - + Operation mode: Manual, Remote control
  - + Last failure history: Failure phase, error mode, current on each phase when fault, fail time
- Data measuring:
  - + Current on each phase: Ia, Ib, Ic, IN
- Data setting:
  - + Overload long-time delay tripping current(Ir) & time(Tr)
  - + Short-circuit short-time delay tripping current(Is) & time(Ts)
  - + Short-circuit instantaneous current(Ii)
  - + N Phase: 50%xIr, 100%xIr
  - + Function switch: On/Off short-circuit short time tripping and thermal memory

### Memory function

- Remote operation control:
  - + Remote control ON/OFF function (Motor operation device is required)

## 1. ETU-COM module

ETU-COM is required for communication function on BM-E series circuit breaker, The features as below:



ETU-COM module

### Specification :

- + Protocol : RS485, ModBus-RTU
- + Baud Rate : 19200bps & 9600bps
- + IP address shall be different in the same network system
- + Data format : 1bit (Start) +8bit(Data)+ 1bit (even)+1bit(Stop)
- + Standard RS485 twisted pair communication cable
- + Max. 32 devices, 1200 meter. With RS485 repeater, more devices and distance can be made

### Connection between circuit breaker and ETU-COM

- + one ETU-COM connects to one circuit breaker with special cable
- + 2 meter long standard cable



**Connect with ETU-COM module & Manual Operation Device**

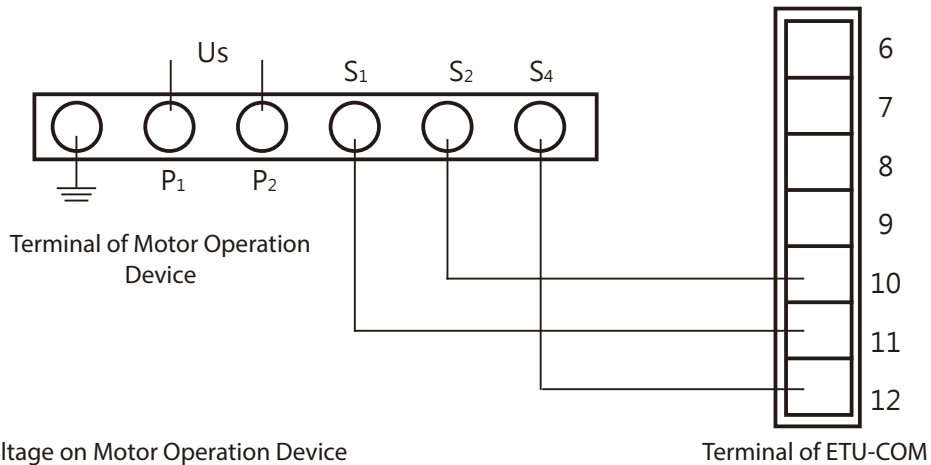

Control voltage on Motor Operation Device  
 $U_s = AC220V \cdot AC110V \cdot DC220V \cdot DC110V \cdot DC24V$

**Connect with ETU-COM & ETU-HUB ( HUB is required for communication function)**



Communication Hub

**Connect with ETU-COM module & Manual Operation Device**

- 6x RS485 port, Max. 5x ETU-COM
- ETU-HUB for communication port extending.
- Install on standard 35mm Din-rail

Noted:  
 ·Special cable required.

- How to connect ETU-HUB and ETU-COM
  - +Cable in 2 meter(Standard accessory of ETU-COM)
  - +Connect between ETU-HUB and ETU-COM

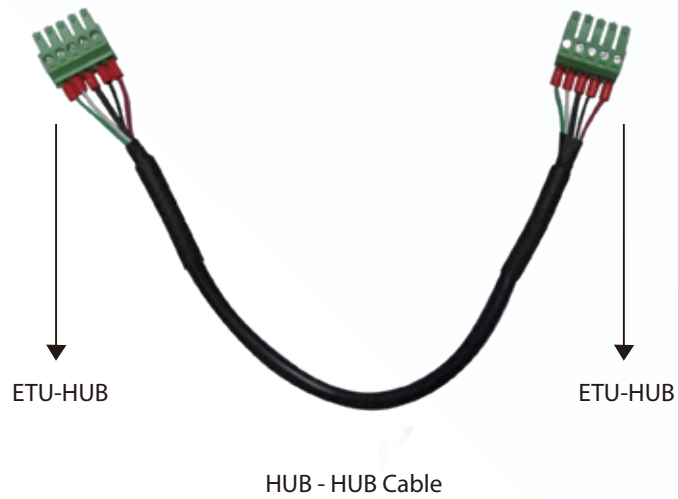
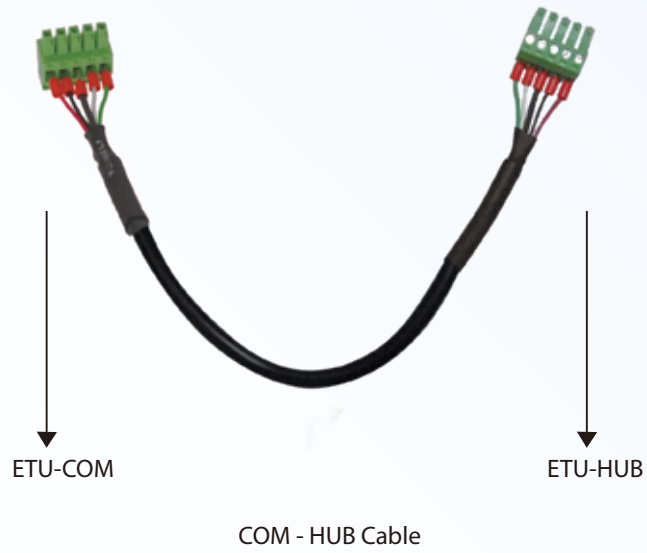

## 2. Connection diagram

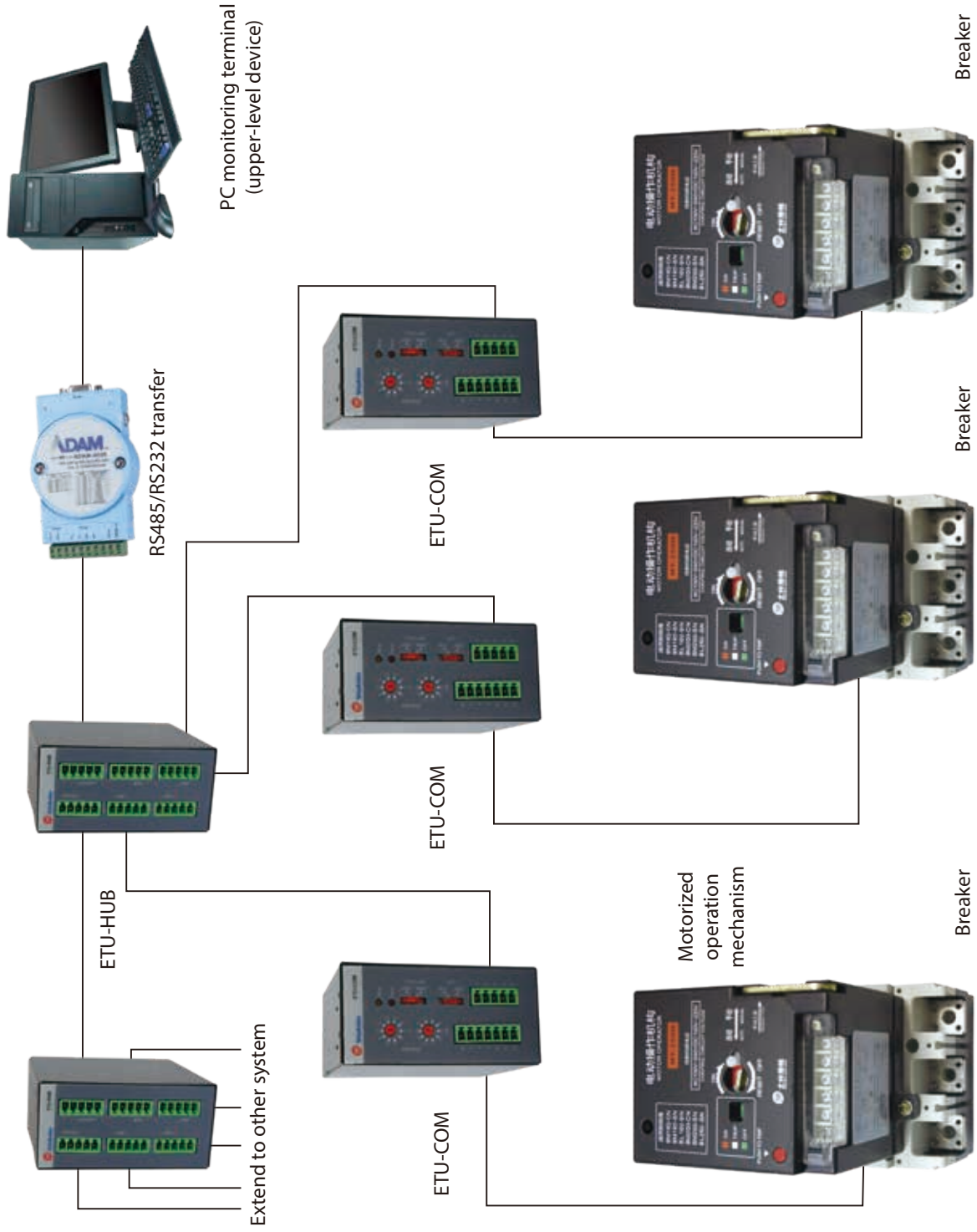







CIRCUIT BREAKER ( MCCB / ELCB / EMCCB / MCB )

## Breaker & Switchgear System



AIR CIRCUIT BREAKER

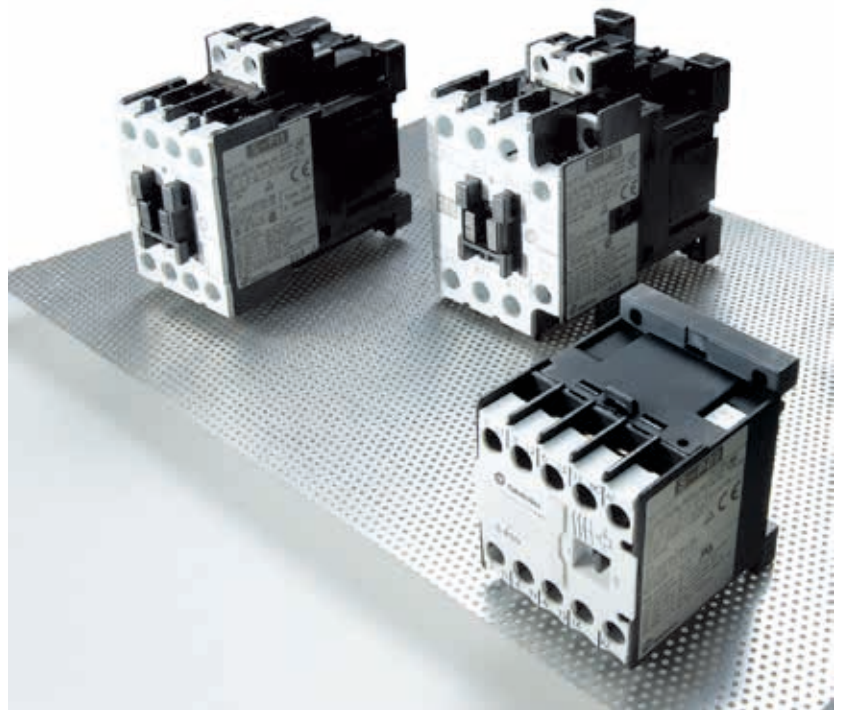

MAGNETIC CONTACTOR / SWITCH ( CONTACTOR / MS / MMS )



AUTOMATIC TRANSFER SWITCHES



SURGE PROTECTIVE DEVICE



SMART METER



INVERTER



LOW VOLTAGE POWER CAPACITORS

# SHIHLIN ELECTRIC & ENGINEERING

MOTOR CONTROL (CONTACTOR/ MS/ MMS), CIRCUIT BREAKER (MCCB/ ELCB/ EMCCB/ MCB), AIR CIRCUIT BREAKER, AUTOMATIC TRANSFER SWITCHES (Panel Board Type/ Residential Unit Use), SURGE PROTECTIVE DEVICE, LOW VOLTAGE POWER CAPACITORS, SMART METER, INVERTER



#### Breaker & switchgears overseas sales dept.

3F, No.9, Sec. 1, Chang-an E. Rd., Zhongshan Dist., Taipei City 10441, Taiwan

T. +886-2-2541-9822 F. +886-2-2581-2665

e-mail. b.export@seec.com.tw

<http://circuit-breaker.seec.com.tw>

#### Headquarters

16F, No.88, Sec. 6, Zhongshan N. Rd., Shilin Dist., Taipei City 11155, Taiwan

T. +886-2-2834-2662 F. +886-2-2836-6187

<http://www.seec.com.tw>

#### KIM QUANG ELECTRIC DISTRIBUTOR

Hotline: 0931 455 668

Sales: 0909 635 266  
0938 118 428

Distributor

B190715E.EMCCB.OB